

Issue 406

Living the Dream

EBC[®] BRAKES



AMERICAN-BUILT MACHINES

**PREMIUM BRAKE PADS - ROTORS - BRAIDED LINES
– CLUTCHES AND CLUTCH INSTALLATION TOOLS**

Our sintered range are proudly made in our Ohio plant
Vee pads, rotors and Organic made in our UK plant

Now producing over 12 million brake pad sets
every year and still going strong after 40 years

www.ebcbrakes.com

MOTORCYCLE BRAKE PADS

FA-Series – Aramid Fiber Organic

- Organic pad with zero metallic content
- Good fingertip feel at the lever
- Low noise
- Easy on rotors
- Medium lifetime pad
- British made



V-Series

- Superb “semi sintered “replacement pad for heavier bikes - top selling grade
- Zero metallic but some copper content for longer life
- Zero rotor damage or noise
- Lifetime almost as good as sintered
- British Made



Double-H™

- USA made in our Ohio plant
- Sintered copper alloy construction
- Superb high brake effect pad outlasting just about everything
- Great pad for heavier touring bikes and sport use
- Zero rotor galling



EPFA-series

- USA made in our Ohio plant
- High spec Sintered copper alloy construction
- Strongest brake feel
- Zero rotor galling
- Higher heat tolerance for heaviest duty street riding



GPFA-Series

- USA made in our Ohio plant
- Higher spec track use formulation
- Sintered copper alloy construction
- Not recommended for street riding due to very high friction level



CONTENTS

Welcome/New Products	2
Stainless Steel Slider Shims/Tech Tips	3
Oversize Rotors/Brake Fluid	4
Clutch Kits and Springs/EBC Brakes Jets	5
Harley-Davidson® Electric	6
Harley-Davidson® X Series	6
Harley-Davidson® Adventure Touring	6
Harley-Davidson® Street	6
Harley-Davidson® Sportster	6
Harley-Davidson® S Series	8
Harley-Davidson® RH Series	8
Harley-Davidson® Dyna	8
Harley-Davidson® Softail	10
Harley-Davidson® Touring	12
Harley-Davidson® Grand American Touring	12
Harley-Davidson® Trike	14
Harley-Davidson® CVO	14
Harley-Davidson® V-Rod	16
Arch	18
ATK	18
Buell	18
Can-Am Canyon	20
Can-Am Ryker	20
Can-Am Spyder	20
EBR	20
Indian	20
Indian	22
Motus	24
Polaris Slingshot	24
Victory	24
Zero Electric	26
Zero Electric	28
Pads For Aftermarket Calipers	30
Brake Pad Buyers Guide (inc. dimensions)	31-36
Rotor Designs and Dimensions/Rotor Bolt Kits	37-53
Brake Lines	54-57
Clutch Kits, Springs and Installation Tools	58-75
Polaris Slingshot Parts	76

WELCOME TO THE EBC 2026 USA-BUILT MOTORCYCLE CATALOG

The world's largest selection of brakes for USA-built motorcycles including our USA-manufactured, sintered pad ranges and UK-made organic and semi-sintered Vee-pads plus a full range and selection of custom replacement brake rotors.

HOW TO USE THIS CATALOG

Pads are simple; simply look up the machine and select the pad type that's best for your customer. On rotors there are sometimes too many choices to list in columns so we use a group number in those cases and you simply take the group number, look at the illustrations and select the one you prefer; solid, floating or oversize.

EBC make different compounds for most calipers and as a guide. FA is the premium Organic grade, X pads are a dry conditions off road pad, V pads are our long lasting semi sintered pad for street use. R pads are a long lasting off road compound, HH is our USA made sintered metal highest brake effect pad, EPFA is our premium Sintered pad, also USA made with super quiet braking and highest temperature capabilities.

KEY TO SYMBOLS

- ⊛ This rotor is made of billet steel and should only be used with EBC FA Organic or Vee Pads.
- * Two sets of brake pads are required for this fitment.
- ▲ Pads sold in axle sets – 4 pads per set.

NEW PRODUCTS FOR 2025/26

EBC BRAKES HAVE ROTOR BOLT KITS SPECIFICALLY FOR HARLEY DAVIDSON

See page 38.



EBC BRAKE ROTORS – BSD BLADE SERIES SPORT SLOTTED ROTORS FOR POLARIS SLINGSHOT AVAILABLE

Add the suffix BSD to specify. Please see page 76.



DOT 4 LOW VISCOSITY BRAKE FLUID

A very high specification brake and clutch fluid.
See page 4.



STAINLESS STEEL SLIDER SHIMS

Stainless steel slider shims are fitted to most of the Hayes rear calipers on Harley Davidson® to prevent wear of the machined aluminum caliper “vee” slider faces and new parts are provided with EBC pads. The important things to note are:



After install, the pads must slide freely within the caliper without dragging and here is the basic procedure to install which is to be read and considered along with your vehicle owners' manual content.



If your bike had NO shims at pad change, do not try to fit shims that needs forcing into the caliper or would render the pads tight or locked UNLESS the pads were loose and rattling (indicating that at a previous service the bike owner or service technician may have forgotten to install shims when they were needed).



Clean up the aluminium slider faces carefully removing all corrosion and scale. Use a fine file or a file wrapped in abrasive paper and remember you are only cleaning off corrosion and scale.



Lightly lube the slider with high temp EBC caliper grease or similar, taking care not to contaminate pads with grease or greasy fingers. Grease on pads renders them ineffective.



Install the stainless slider shims.



Clean off any paint or burrs in the ears of the pads with a fine file and slip them onto the slider shims. The pads should be a light push fit with thumbs and if you have to force them you have either left scale or corrosion under the shims, the ears of the pad have paint or burrs in them or your caliper model did NOT need shims. Never force or hammer the pads into the caliper.



If you have any doubts contact a qualified service technician.



After brake install, raise the bike wheel and rotate the wheel, pumping and releasing the brakes to check for free spinning of the wheel and free releasing of the brakes. Test ride vehicle carefully applying the brakes intermittently for a few miles to evaluate brake drag and brake release. If rotors become blued or hot spotted or seem in anyway to be overheating, see a qualified technician. Do not ride the bike with dragging brakes.

TECH TIPS



MOST EBC PADS are not designed to re-use any original **BACKING SHIMS**. See pad diagrams for guidance on where shims may be refitted without causing problems, but even then, always check caliper mounts easily over the rotor and has a few thousandths of free float, and is not tight or causing drag, rotate wheels and operate brakes a few times with wheel lifted to check for free brake and no drag.



EBC front pads, reference FA94 are supplied with a larger (stronger) retainer screw, this has a different thread to the original parts and this screw should only be used with the EBC product.



Always caution the vehicle user/owner to check pad wear every month visually or after 3000 miles of riding, and replace pads when 1/16” of material left on backing plates. Running pads below this level is dangerous.



Many US built motorcycles use **SILICONE BRAKE FLUID**, always check carefully in the owners manual as to which fluid is required, never mix silicone fluids with glycols as this will cause sludging and ineffective brakes.



No EBC pads have ever contained asbestos, but some low cost aftermarket brands you look to replace may have. Therefore, always observe safety procedures when removing old pads and cleaning away dust. Use a wet cloth and dispose of safely after use.



All EBC organic pads now feature the revolutionary **Nucap®** (Canada) **NRS®** hook system. This guarantees the perfection of bond strength on pads. This allows EBC to use even chromed backing plates as the puck itself is retained by strong Velcro-like fingers that protrude about 1/32” into the pad material.



When installing new pads and/or rotors always advise the rider to bed in brakes gently, using progressively stronger braking pressure over the first 300-500 miles, riding the vehicle slowly, and allowing extra braking distance until the brakes feel strong.

OVERSIZE ROTORS

Billet aluminum caliper relocation brackets are also available to fit EBC Brakes range of 14" and 15" oversize full floating front rotors. Plain rotors with a choice of polished or black chrome hubs are available for all big twins to improve brake performance and brake modulation, increasing stopping power by 25-30%. 15" rotors for single front fitments are made with a 6mm 1/4" thick rotor blade.

CALIPER RELOCATION BRACKET

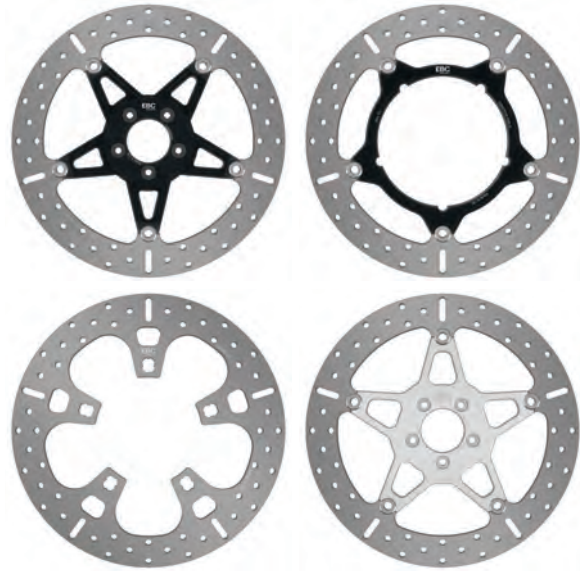

BRAKE FLUID

Now tested to meet Florida EPA requirements. Bottle label shows all specifications of the fluid.



A refined specification polyglycol fluid as fitted to most faster street bikes now produced.

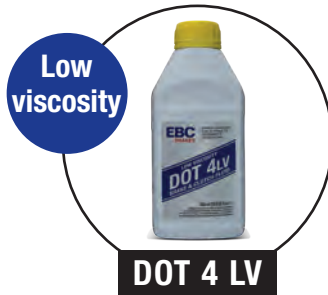

Advanced low viscosity fluid, to optimise the performance of ESP/ASR (Electronic Stability Program) systems.



Silicone fluid as used in Harley Davidson Motorcycles and many special High Performance Brake systems.



Highly refined DOT 4 Brake fluid, ideal for Racing or High Performance Road bikes. Can be used in all systems specifying DOT 4 but **NOT** with (DOT 5) silicone fluids.

TO ORDER USE THESE PART NUMBERS

SIX PACK		SINGLE BOTTLES	
DOT 4 (Six Pack)	BF004	DOT 4 (Single)	BF004A
DOT 5 (Six Pack) (Silicone)	BF005	DOT 5 (Single) (Silicone)	BF005A
BF 307 (Six Pack)	BF307	BF 307 (Single)	BF307A
DOT 4 LV (Six Pack)	BF004LV-6	DOT 4 LV (Single)	BF004LV

CAUTION: Please check carefully the type of brake fluid used in your system. Adding incorrect fluids could cause major brake failure. DO NOT ever mix glycol fluids (DOT 4 or BF-307) with DOT 5 silicone.

Check your owners manual to see if your system is based on Silicone or Glycol fluid.
Some pre 2005 Harley® models did use Silicone.

CLUTCH KITS AND SPRINGS

EBC Brakes CK friction plate kits contain a complete engine set of stack height controlled friction plates with a unique alloy impregnated clutch facings to prevent burn up and slippage. EBC Brakes SRC series is an aramid fiber lined friction plate set with heavy duty diaphragm springs where required. SRK series includes a full set of friction plates, steel plates and heavy duty diaphragm clutch springs where required. EBC Brakes offer CSK heavy duty clutch coil or diaphragm clutch springs kits where appropriate. EBC Brakes also offer a comprehensive list of clutch holding tools for removal and loosening of the drive shafts bolts and re-tightening a breeze without damaging your expensive clutch basket.

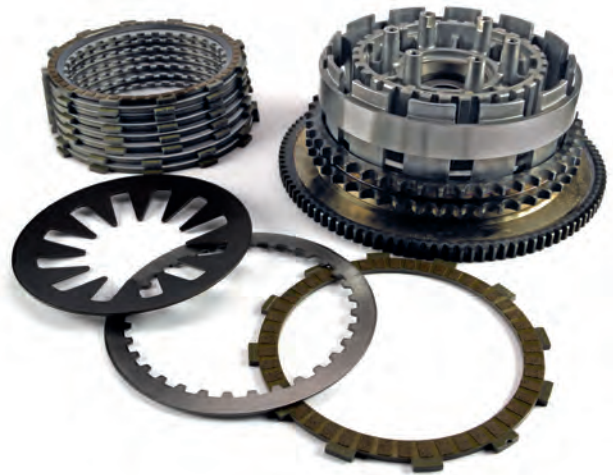

EBC BRAKES JETS

A-BAX Precision Engineering Ltd brass main jets for Keihin CVH carburetors, used on most big twins. Sold in packets of 2 pieces and in dealer assortment kits of 12 sizes (2 pieces each size).



**DEALER SELECTION KIT
PART NO – HDJK-12**

MAIN JETS

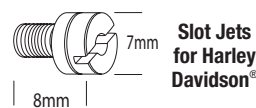

Slot Jets
for Harley
Davidson®

424-27 slotted series
part numbers below are
for a packet of 2 jets.



SIZES AVAILABLE

EBC424-27-165
EBC424-27-170
EBC424-27-175
EBC424-27-180
EBC424-27-185
EBC424-27-190
EBC424-27-195
EBC424-27-200
EBC424-27-205
EBC424-27-210
EBC424-27-220

PILOT JETS

Pilot Jets
for Harley Davidson®
(Sold as singles)

Jet Style – N424-25
Pilot / Slow Running Jet
FCR 28 / 32 / 33 / 35 / 37 / 39 / 41mm
Harley® D Keihin BH (Non CV Type)



Size Part

35	EBC424-25-35
38	EBC424-25-38
40	EBC424-25-40
42	EBC424-25-42
45	EBC424-25-45
48	EBC424-25-48
50	EBC424-25-50
52	EBC424-25-52
55	EBC424-25-55
58	EBC424-25-58
60	EBC424-25-60
62	EBC424-25-62
65	EBC424-25-65

FRONT: AMERICAN PRODUCED MOTORCYCLES



SUFFIX OR PREFIX
PAD MATERIALS AND DESCRIPTION

YEAR

FRONT

PADS	PADS	PADS	PADS	FRONT ROTOR OPTIONS	BOLTS
Organic Pads	Semi-Sintered V-Pads™	Double-H™ USA-Made Sintered Pads	Premium Low Noise Street Sintered Pads	See Buyers Guide for rotor style & finish options. Part nos for ordering & sizing.	Rotor Bolt Kits
HARLEY-DAVIDSON® ELECTRIC					
LiveWire				017	
S2 Del Mar/Alpinista/Mulholland					
HARLEY-DAVIDSON® X SERIES					
X350					
X440					
X500					
HARLEY-DAVIDSON® ADVENTURE TOURING					
RA 1250 Pan America Adventure					
RA 1250 S Pan America Adventure Special					
RA 1250SE Pan America CVO					
RA 1250 Pan America Adventure ST					
RA 1250 S Pan America Adventure Special					
HARLEY-DAVIDSON® STREET					
XG 500 Street					
XG 500 Street 300mm Rotors				022	
XG 750 Street					
XG 750 Street 300mm Rotors				022	
XG 750A Street Rod 300mm Rotors				022	
HARLEY-DAVIDSON® SPORTSTER					
XLH 883				002	HBK001
XL 53c *Oversize Rotor Available				001	HBK001
XLH 883 Hugger *Oversize Rotor Available				001	HBK001
XL 883 R Sportster Flat Track *Oversize Rotor Available				001	HBK001
XL 883 R 100th Anniversary Edition *Oversize Rotor Available				001	HBK001
XL 883 C Sportster *Oversize Rotor Available				001	HBK001
XL 883 Hugger *Oversize Rotor Available				001	HBK001
XL 883 R Sportster *Oversize Rotor Available				001	HBK001
XL 883 Sportster Standard *Oversize Rotor Available				001	HBK001
XL 883 L Low *Oversize Rotor Available				001	HBK001
XL 883 N Iron Cast Wheel *Oversize Rotor Available				001	HBK001
XL 883 L Superlow *Oversize Rotor Available				001	HBK001
XL 883 L Superlow Cast Wheel *Oversize Rotor Available				010	HBK002
XL 883 N Iron *Oversize Rotor Available				010	HBK002
XL 883 R Roadster Cast Wheel *Oversize Rotor Available				010	HBK002
XLH, XLCH Rivet Type					
XLH 1000					
XLH 1000				002	HBK001
XLH 1200 Hayes Caliper				002	HBK001
XL 1200 *Oversize Rotor Available				001	HBK001
XL 1200 Custom *Oversize Rotor Available				001	HBK001
XL 1200 S *Oversize Rotor Available				001	HBK001
XL 1200 *Oversize Rotor Available				001	HBK001
XL 1200 Custom *Oversize Rotor Available				001	HBK001
XL 1200 R *Oversize Rotor Available				001	HBK001
XL 1200 R Sportster Roadster *Oversize Rotor Available				001	HBK001
XL 1200 L *Oversize Rotor Available				001	HBK001
XL 1200 N Nightster *Oversize Rotor Available				001	HBK001
XL 50 Anniversary 1200 *Oversize Rotor Available				001	HBK001
XR 1200				001	HBK001
XL 1200 X Forty Eight *Oversize Rotor Available				001	HBK001
XR 1200 X				001	HBK001

*Oversize Rotor Available - see buyer's guide

* symbol after part# = 2 pieces required i.e. 2 pad sets or 2 rotors (twin rotor models)

FRONT: AMERICAN PRODUCED MOTORCYCLES



SUFFIX OR PREFIX
PAD MATERIALS AND DESCRIPTION

		FRONT						Line #
		PADS	PADS	PADS	PADS	FRONT ROTOR OPTIONS	BOLTS	
		FA	V	HH	EPFA	DESIGN NO.	HBK No.	
YEAR		Organic Pads	Semi-Sintered V-Pads™	Double-H™ USA-Made Sintered Pads	Premium Low Noise Street Sintered Pads	See Buyers Guide for rotor style & finish options. Part nos for ordering & sizing.	Rotor Bolt Kits	
HARLEY-DAVIDSON® SPORTSTER								
XL 1200 V Seventy Two *Oversize Rotor Available	2011-2013	FA381	FA381V	FA381HH	EPFA381HH	001	HBK001	1
XL 1200 C Custom - Oversize Rotor Available	2014-2021	FA640	FA640V	FA640HH	EPFA640HH	010	HBK002	2
XL 1200 T Superlow - Oversize Rotor Available	2014-2021	FA640	FA640V	FA640HH	EPFA640HH	010	HBK002	3
XL 1200 V Seventy Two - Oversize Rotor Available	2014-2016	FA640	FA640V	FA640HH	EPFA640HH	010	HBK002	4
XL 1200 X Forty Eight - Oversize Rotor Available	2014-2023	FA640	FA640V	FA640HH	EPFA640HH	010	HBK002	5
XL 1200 CX Roadster - Oversize Rotor Available	2016-2021	FA640*	FA640V*	FA640HH*	EPFA640HH*	010	HBK002	6
XL 1200 NS Iron - Oversize Rotor Available	2018-2021	FA640	FA640V	FA640HH	EPFA640HH	010	HBK002	7
XL 1200 XS Forty Eight Special - Oversize Rotor Available	2018-2020	FA640	FA640V	FA640HH	EPFA640HH	010	HBK002	8
XL 1200 XSANX Forty Eight Anniversary - Oversize Rotor Available	2018	FA640	FA640V	FA640HH	EPFA640HH	010	HBK002	9
HARLEY-DAVIDSON® S SERIES								
FLSS Softail Slim S - Oversize Rotor Available	2016-2020			FA296HH	EPFA296HH	010	HBK002	11
FLSTFBS Fat Boy S - Oversize Rotor Available	2016-2018			FA296HH	EPFA296HH	010	HBK002	13
HARLEY-DAVIDSON® RH SERIES								
RH 975 Nightster	2022-2026	FA409	FA409V	FA409HH	EPFA409HH			16
RH 975S Nightster Special	2023-2026	FA409	FA409V	FA409HH	EPFA409HH			17
RH 1250S Sportster S	2021-2026	FA630	FA630V	FA630HH	EPFA630HH			18
HARLEY-DAVIDSON® DYNA								
FL, FLH Banana Caliper	1980-1983	FA24/2	FA24/2V					21
FXD,FXDL,FXDWG,FXR,FXRS,FXRT,FXRD,FXLR	1982-1983	FA71*	FA71V*					22
FX, FXE Rivet type	1973-1977	FA26						23
FX, FXE, FXS Late 1978-1983	1978-1983	FA71	FA71V					24
FXWG, FXSB	1983	FA71	FA71V			002	HBK001	25
FX, FXE, FXS Hayes Caliper	1984-1986	FA94*	FA94V*	FA94HH*	EPFA94HH*	002	HBK001	26
FXD/L/WG, FXR/S/T/D/R 1984-Early 1987 Hayes Caliper	1984-1987	FA94*	FA94V*	FA94HH*	EPFA94HH*	002	HBK001	27
FXD/L/WG, FXR/S/T/D, FXLR Late 1987-1999 Hayes Caliper	1987-1999	FA94*	FA94V*	FA94HH*	EPFA94HH*	002	HBK001	28
FXDS Glide Convertible 1450 *Oversize Rotor Available	1999-2000	FA400*	FA400V*	FA400HH*	EPFA400HH*	001	HBK002	29
FXD Super Glide *Oversize Rotor Available	2000-2003	FA400	FA400V	FA400HH	EPFA400HH	001	HBK001	30
FXDL Low Rider *Oversize Rotor Available	2000-2003	FA400*	FA400V*	FA400HH*	EPFA400HH*	001	HBK001	31
FXDWG Wide Glide *Oversize Rotor Available	2000-2003	FA400*	FA400V*	FA400HH*	EPFA400HH*	001	HBK002	32
FXDX Super Glide Sport *Oversize Rotor Available	2000-2003	FA400*	FA400V*	FA400HH*	EPFA400HH*	001	HBK002	33
FXDXT Superglide T-Sport *Oversize Rotor Available	2001-2003	FA400*	FA400V*	FA400HH*	EPFA400HH*	001	HBK002	34
FXDi Super Glide *Oversize Rotor Available	2004-2007	FA400	FA400V	FA400HH	EPFA400HH	001	HBK001	35
FXDLi Low Rider *Oversize Rotor Available	2004-2007	FA400	FA400V	FA400HH	EPFA400HH	001	HBK002	36
FXDWGi Wide Glide *Oversize Rotor Available	2004-2007	FA400	FA400V	FA400HH	EPFA400HH	001	HBK002	37
FXDXi Super Glide Sport *Oversize Rotor Available	2004-2005	FA400*	FA400V*	FA400HH*	EPFA400HH*	001	HBK002	38
FXDCi Superglide Custom *Oversize Rotor Available	2005-2007	FA400	FA400V	FA400HH	EPFA400HH	001	HBK001	39
FXDBi Street Bob *Oversize Rotor Available	2006-2007	FA400	FA400V	FA400HH	EPFA400HH	001	HBK001	40
FXDi Super Glide *Oversize Rotor Available	2006-2007	FA400	FA400V	FA400HH	EPFA400HH	006		41
FXDLi Low Rider	2006-2007	FA400	FA400V	FA400HH	EPFA400HH	006		42
FXD Super Glide *Oversize Rotor Available	2008-2010	FA457	FA457V	FA457HH	EPFA457HH	006		43
FXDWG Dyna Wide Glide *Oversize Rotor Available	2008-2020	FA457	FA457V	FA457HH	EPFA457HH	010	HBK002	44
FXDWG Wide Glide *Oversize Rotor Available	2008	FA457	FA457V	FA457HH	EPFA457HH	010	HBK002	45
FXDB Street Bob *Oversize Rotor Available	2008-2020	FA457	FA457V	FA457HH	EPFA457HH	010	HBK002	46
FXDC Super Glide Custom 96 *Oversize Rotor Available	2008-2014	FA457	FA457V	FA457HH	EPFA457HH	010	HBK002	47
FXDF Fat Bob	2008-2010	FA457*	FA457V*	FA457HH*	EPFA457HH*	010		48
FXDL Low Rider *Oversize Rotor Available	2008-2013	FA457	FA457V	FA457HH	EPFA457HH	010	HBK002	49
FXDF 96 Fat Bob *Oversize Rotor Available	2011-2017	FA457*	FA457V*	FA457HH*	EPFA457HH*	010	HBK002	50
FXDWG Dyna Wide Glide 96 *Oversize Rotor Available	2011-2015	FA457	FA457V	FA457HH	EPFA457HH	010	HBK002	51
FLD Switchback *Oversize Rotor Available	2012-2016	FA457	FA457V	FA457HH	EPFA457HH	010	HBK002	52
FXDL Low Rider 103 *Oversize Rotor Available	2014-2017	FA457*	FA457V*	FA457HH*	EPFA457HH*	010	HBK002	53
FXDBC Street Bob Limited *Oversize Rotor Available	2016	FA457*	FA457V*	FA457HH*	EPFA457HH*	010	HBK002	54
FXDLS Low Rider S *Oversize Rotor Available	2016-2017	FA457*	FA457V*	FA457HH*	EPFA457HH*	010	HBK002	55

* symbol after part# = 2 pieces required i.e. 2 pad sets or 2 rotors (twin rotor models)

*Oversize Rotor Available - see buyer's guide

FRONT: AMERICAN PRODUCED MOTORCYCLES



SUFFIX OR PREFIX
PAD MATERIALS AND DESCRIPTION

YEAR	FRONT						FRONT ROTOR OPTIONS DESIGN NO.	HBK No.	Rotor Bolt Kits
	PADS	PADS	PADS	PADS	FRONT ROTOR OPTIONS	BOLTS			
	FA	V	HH	EPFA	DESIGN NO.	HBK No.			
	Organic Pads	Semi-Sintered V-Pads™	Double-H™ USA-Made Sintered Pads	Premium Low Noise Street Sintered Pads	See Buyers Guide for rotor style & finish options. Part nos for ordering & sizing.				
FXST/B/C/S, FLST/C/F/S/N Hayes Caliper	1984-1987	FA94	FA94V	FA94HH	EPFA94HH	002	HBK001	1	
FXST/B/C/S, FLST/C/F/S/N Hayes Caliper	1987-1999	FA94	FA94V	FA94HH	EPFA94HH	002	HBK001	2	
FLSTC Heritage Classic *Oversize Rotor Available	2000-2007	FA400	FA400V	FA400HH	EPFA400HH	001	HBK002	3	
FLSTF Fat Boy *Oversize Rotor Available	2000-2007	FA400	FA400V	FA400HH	EPFA400HH	001	HBK002	4	
FLSTS Heritage Springer Hayes Caliper *Oversize Rotor Available	2000-2003	FA94	FA94V	FA94HH	EPFA94HH	001	HBK002	5	
FXST Softail Standard *Oversize Rotor Available	2000-2005	FA400	FA400V	FA400HH	EPFA400HH	001	HBK002	6	
FXSTB Night Train *Oversize Rotor Available	2000-2005	FA400	FA400V	FA400HH	EPFA400HH	001	HBK002	7	
FXSTD Deuce *Oversize Rotor Available	2000-2007	FA400	FA400V	FA400HH	EPFA400HH	001	HBK002	8	
FXSTS Springer Hayes Caliper	2000-2005	FA94	FA94V	FA94HH	EPFA94HH	002	HBK001	9	
FLSTFI Fat Boy 15th Anniversary Edition *Oversize Rotor Available	2005	FA400	FA400V	FA400HH	EPFA400HH	001	HBK002	10	
FLSTNi Softail Deluxe *Oversize Rotor Available	2005-2007	FA400	FA400V	FA400HH	EPFA400HH	001	HBK002	11	
FLSTSC/FLSTSCI Springer Classic Hayes Caliper *Oversize Rotor Available	2006-2007	FA94	FA94V	FA94HH	EPFA94HH	001	HBK002	12	
FXST Softail Standard *Oversize Rotor Available	2006-2007	FA400	FA400V	FA400HH	EPFA400HH	001	HBK002	13	
FXSTBi Night Train *Oversize Rotor Available	2006-2007	FA400	FA400V	FA400HH	EPFA400HH	001	HBK002	14	
FXSTC Softail Custom *Oversize Rotor Available	2007	FA400	FA400V	FA400HH	EPFA400HH	001	HBK002	15	
FLSTC Heritage Softail Classic *Oversize Rotor Available	2008-2014	FA457	FA457V	FA457HH	EPFA457HH	001	HBK002	16	
FXCW Rocker *Oversize Rotor Available	2008-2011	FA457	FA457V	FA457HH	EPFA457HH	001	HBK002	17	
FXCWC Rocker C *Oversize Rotor Available	2008-2011	FA457	FA457V	FA457HH	EPFA457HH	001	HBK002	18	
FXSTB Night Train *Oversize Rotor Available	2008-2009	FA457	FA457V	FA457HH	EPFA457HH	001	HBK002	19	
FXSTC Softail Custom *Oversize Rotor Available	2008-2010	FA457	FA457V	FA457HH	EPFA457HH	001	HBK002	20	
FLSTN Softail Deluxe *Oversize Rotor Available	2008-2014	FA457	FA457V	FA457HH	EPFA457HH	001	HBK001	21	
FLSTSB Softail Cross Bones *Oversize Rotor Available	2008-2011	FA94	FA94V	FA94HH	EPFA94HH	001	HBK001	22	
FLSTFB Fat Boy LO *Oversize Rotor Available	2010-2011	FA457	FA457V	FA457HH	EPFA457HH	001	HBK002	23	
FXS Blackline *Oversize Rotor Available	2011-2013	FA457	FA457V	FA457HH	EPFA457HH	001	HBK001	24	
FXST Softail Standard *Oversize Rotor Available	2011-2014	FA457	FA457V	FA457HH	EPFA457HH	001	HBK001	25	
FLS Softail Slim *Oversize Rotor Available	2012-2014	FA457	FA457V	FA457HH	EPFA457HH	001	HBK002	26	
FXSB Breakout 96 *Oversize Rotor Available	2013-2014	FA457	FA457V	FA457HH	EPFA457HH	001	HBK001	27	
FXST Softail Standard 96 *Oversize Rotor Available	2014-2017			FA296HH	EPFA296HH	010	HBK002	28	
FXSB Breakout 96 & 103 *Oversize Rotor Available	2015-2017			FA296HH	EPFA296HH	010	HBK002	29	
FLS Softail Slim 103 *Oversize Rotor Available	2015-2017			FA296HH	EPFA296HH	010	HBK002	30	
FLSTC Heritage Softail Classic 103 *Oversize Rotor Available	2015-2017			FA296HH	EPFA296HH	010	HBK002	31	
FLSTFB Fat Boy LO *Oversize Rotor Available	2015-2017			FA296HH	EPFA296HH	010	HBK002	32	
FLSTN Softail Deluxe 96 *Oversize Rotor Available	2015-2017			FA296HH	EPFA296HH	010	HBK002	33	
FLFB Fatboy 107 *Oversize Rotor Available	2018-2022			FA296HH	EPFA296HH	010	HBK002	34	
FLDE Deluxe 107 *Oversize Rotor Available	2018-2022			FA296HH	EPFA296HH	010	HBK002	35	
FLHC Heritage Classic 107 *Oversize Rotor Available	2018-2022			FA296HH	EPFA296HH	010	HBK002	36	
FLSB Sport Glide 107 *Oversize Rotor Available	2018-2026			FA296HH	EPFA296HH	010	HBK002	37	
FLSL Softail Slim 107 *Oversize Rotor Available	2018-2022			FA296HH	EPFA296HH	010	HBK002	38	
FXBB Street Bob 107 *Oversize Rotor Available	2018-2026			FA296HH	EPFA296HH	010	HBK002	39	
FXBR Breakout *Oversize Rotor Available	2018-2020			FA296HH	EPFA296HH	010	HBK002	40	
FXFB Fat Bob *Oversize Rotor Available	2018-2020			FA296HH*	EPFA296HH*	010	HBK002	41	
FXFBS Fat Bob 107 & 114 *Oversize Rotor Available	2018-2023			FA296HH*	EPFA296HH*	010	HBK002	42	
FXLR Low Rider 107 *Oversize Rotor Available	2018-2020			FA296HH*	EPFA296HH*	010	HBK002	43	
FXST Softail Standard 107 *Oversize Rotor Available	2020-2024			FA296HH	EPFA296HH	010	HBK002	44	
FLSTF Fat Boy *Oversize Rotor Available	2008-2014	FA457	FA457V	FA457HH	EPFA457HH	001	HBK001	45	
FLSTF Fat Boy *Oversize Rotor Available	2015-2017			FA296HH	EPFA296HH	010	HBK002	46	
FLSTFBS Fat Boy S *Oversize Rotor Available	2016-2017			FA296HH	EPFA296HH	010	HBK002	47	
FLFBS Fat Boy 114 *Oversize Rotor Available	2018-2026			FA296HH	EPFA296HH	010	HBK002	48	
FLFBS Fat Boy 114 Anniversary *Oversize Rotor Available	2018			FA296HH	EPFA296HH	010	HBK002	49	
FLHCS Heritage Classic 114 *Oversize Rotor Available	2018-2026			FA296HH	EPFA296HH	010	HBK002	50	
FLHCS Heritage Classic 114 Anniversary *Oversize Rotor Available	2018-2020			FA296HH	EPFA296HH	010	HBK002	51	
FXBR Breakout 114 *Oversize Rotor Available	2018-2024			FA296HH	EPFA296HH	010	HBK002	52	
FXBRS Breakout 114 Anniversary *Oversize Rotor Available	2018-2020			FA296HH	EPFA296HH	010	HBK002	53	
FXDR 114-FXDRS *Oversize Rotor Available	2019-2020			FA296HH*	EPFA296HH*	010	HBK002	54	
FXFBS Fat Bob 114 *Oversize Rotor Available	2019-2023			FA296HH*	EPFA296HH*	010	HBK002	55	

* symbol after part# = 2 pieces required i.e. 2 pad sets or 2 rotors (twin rotor models)

*Oversize Rotor Available - see buyer's guide

REAR: AMERICAN PRODUCED MOTORCYCLES



Line #

HARLEY-DAVIDSON® SOFTAIL

SUFFIX OR PREFIX
PAD MATERIALS AND DESCRIPTION

YEAR

REAR						REAR ROTOR OPTIONS	BOLTS		
PADS	PADS	PADS	PADS						
FA	V	HH	EPFA	DESIGN NO.	HBK No.				
Organic Pads	Semi-Sintered V-Pads™	Double-H™ USA-Made Sintered Pads	Premium Low Noise Street Sintered Pads	See Buyers Guide for rotor style & finish options. Part nos for ordering & sizing.	Rotor Bolt Kits				
1	FXST/B/C/S, FLST/C/F/S/N	Girling Caliper	1984-1987	FA78	FA78V	FA78HH			
2	FXST/B/C/S, FLST/C/F/S/N		1987-1999	FA200	FA200V	FA200HH	EPFA200HH	004	
3	FLSTC	Heritage Classic	2000-2007	FA400	FA400V	FA400HH	EPFA400HH	003	HBK004
4	FLSTF	Fat Boy	2000-2007	FA400	FA400V	FA400HH	EPFA400HH	003	HBK004
5	FLSTS	Heritage Springer	2000-2003	FA400	FA400V	FA400HH	EPFA400HH	003	HBK004
6	FXST	Softail Standard	2000-2005	FA400	FA400V	FA400HH	EPFA400HH	003	HBK004
7	FXSTB	Night Train	2000-2005	FA400	FA400V	FA400HH	EPFA400HH	003	HBK004
8	FXSTD	Deuce	2000-2007	FA400	FA400V	FA400HH	EPFA400HH	003	HBK004
9	FXSTS	Springer	2000-2005	FA400	FA400V	FA400HH	EPFA400HH	003	HBK004
10	FLSTFi	Fat Boy 15th Anniversary Edition	2005	FA400	FA400V	FA400HH	EPFA400HH	003	HBK004
11	FLSTNi	Softail Deluxe	2005-2007	FA400	FA400V	FA400HH	EPFA400HH	003	HBK004
12	FLSTSC/FLSTSCI	Springer Classic	2006-2007	FA400	FA400V	FA400HH	EPFA400HH	003	HBK004
13	FXST	Softail Standard	2006-2007	FA434	FA434V	FA434HH		003	HBK004
14	FXSTBi	Night Train	2006-2007	FA434	FA434V	FA434HH		003	HBK004
15	FXSTC	Softail Custom	2007	FA434	FA434V	FA434HH		003	HBK004
16	FLSTC	Heritage Softail Classic	2008-2014	FA458	FA458V	FA458HH	EPFA458HH	003	HBK004
17	FXCW	Rocker	2008-2011	FA458	FA458V	FA458HH	EPFA458HH	003	HBK004
18	FXCWC	Rocker C	2008-2011	FA458	FA458V	FA458HH	EPFA458HH	003	HBK004
19	FXSTB	Night Train	2008-2009	FA458	FA458V	FA458HH	EPFA458HH	003	HBK004
20	FXSTC	Softail Custom	2008-2010	FA458	FA458V	FA458HH	EPFA458HH	003	HBK004
21	FLSTN	Softail Deluxe	2008-2014	FA458	FA458V	FA458HH	EPFA458HH	003	HBK004
22	FLSTSB	Softail Cross Bones	2008-2011	FA458	FA458V	FA458HH	EPFA458HH	003	HBK004
23	FLSTFB	Fat Boy LO	2010-2011	FA458	FA458V	FA458HH	EPFA458HH	003	HBK004
24	FXS	Blackline	2011-2013	FA458	FA458V	FA458HH	EPFA458HH	003	HBK004
25	FXST	Softail Standard	2011-2014	FA458	FA458V	FA458HH	EPFA458HH	003	HBK004
26	FLS	Softail Slim	2012-2014	FA458	FA458V	FA458HH	EPFA458HH	003	HBK004
27	FXSB	Breakout 96	2013-2014	FA458	FA458V	FA458HH	EPFA458HH	003	HBK004
28	FXST	Softail Standard 96	2014-2017		FA710V	FA710HH	EPFA710HH	003	HBK004
29	FXSB	Breakout 96 & 103	2015-2017	FA458	FA458V	FA458HH	EPFA458HH	003	HBK004
30	FLS	Softail Slim 103	2015-2017	FA458	FA458V	FA458HH	EPFA458HH	003	HBK004
31	FLSTC	Heritage Softail Classic 103	2015-2017	FA458	FA458V	FA458HH	EPFA458HH	003	HBK004
32	FLSTFB	Fat Boy LO	2015-2017	FA458	FA458V	FA458HH	EPFA458HH	003	HBK004
33	FLSTN	Softail Deluxe 96	2015-2017	FA458	FA458V	FA458HH	EPFA458HH	003	HBK004
34	FLFB	Fatboy 107	2018-2022		FA710V	FA710HH	EPFA710HH	003	HBK004
35	FLDE	Deluxe 107	2018-2022		FA710V	FA710HH	EPFA710HH	003	HBK004
36	FLHC	Heritage Classic 107	2018-2022		FA710V	FA710HH	EPFA710HH	003	HBK004
37	FLSB	Sport Glide 107	2018-2026		FA710V	FA710HH	EPFA710HH	003	HBK004
38	FLSL	Softail Slim 107	2018-2022		FA710V	FA710HH	EPFA710HH	003	HBK004
39	FXBB	Street Bob 107	2018-2026		FA710V	FA710HH	EPFA710HH	003	HBK004
40	FXBR	Breakout	2018-2020		FA710V	FA710HH	EPFA710HH	003	HBK004
41	FXFB	Fat Bob	2018-2020		FA710V	FA710HH	EPFA710HH	003	HBK004
42	FXFBS	Fat Bob 107 & 114	2018-2023		FA710V	FA710HH	EPFA710HH	003	HBK004
43	FXLR	Low Rider 107	2018-2020		FA710V	FA710HH	EPFA710HH	003	HBK004
44	FXST	Softail Standard 107	2020-2024		FA710V	FA710HH	EPFA710HH	003	HBK004
45	FLSTF	Fat Boy	2008-2014	FA458	FA458V	FA458HH	EPFA458HH	003	HBK004
46	FLSTF	Fat Boy	2015-2017	FA458	FA458V	FA458HH	EPFA458HH	003	HBK004
47	FLSTFBS	Fat Boy S	2016-2017	FA458	FA458V	FA458HH	EPFA458HH	003	HBK004
48	FLFBS	Fat Boy 114	2018-2026		FA710V	FA710HH	EPFA710HH	003	HBK004
49	FLFBS	Fat Boy 114 Anniversary	2018		FA710V	FA710HH	EPFA710HH	003	HBK004
50	FLHCS	Heritage Classic 114	2018-2026		FA710V	FA710HH	EPFA710HH	003	HBK004
51	FLHCS	Heritage Classic 114 Anniversary	2018-2020		FA710V	FA710HH	EPFA710HH	003	HBK004
52	FXBR	Breakout 114	2018-2024		FA710V	FA710HH	EPFA710HH	003	HBK004
53	FXBRS	Breakout 114 Anniversary	2018-2020		FA710V	FA710HH	EPFA710HH	003	HBK004
54	FXDR	114-FXDRS	2019-2020	FA387	FA387V	FA387HH	EPFA387HH		
55	FXFBS	Fat Bob 114	2019-2023		FA710V	FA710HH	EPFA710HH	003	HBK004

* symbol after part# = 2 pieces required i.e. 2 pad sets or 2 rotors (twin rotor models)

Part numbers, prefixes, suffixes, photos and illustrations shown in this catalog are trademarks and/or copyrights of EBC Brakes or the trademark owner A C Freeman Investments Ltd and use without express written permission of the owners is punishable by law.

All names & numbers are for reference purposes only. © Registered trademarks of Harley—Davidson® Motor Corp or Buell.

NOTE: — Some models may have a second rotor fitted as an optional extra. Please double check with your customer exactly which side the front rotor is fitted and if twin rotor or single.

⊗ This symbol indicates a rotor made of billet steel, and should be only used with EBC FA Organic or Vee pads.

FRONT: AMERICAN PRODUCED MOTORCYCLES



SUFFIX OR PREFIX
PAD MATERIALS AND DESCRIPTION

		FRONT						Line #
		PADS	PADS	PADS	PADS	FRONT ROTOR OPTIONS	BOLTS	
		FA	V	HH	EPFA	DESIGN NO.	HBK No.	
YEAR		Organic Pads	Semi-Sintered V-Pads™	Double-H™ USA-Made Sintered Pads	Premium Low Noise Street Sintered Pads	See Buyers Guide for rotor style & finish options. Part nos for ordering & sizing.	Rotor Bolt Kits	
HARLEY-DAVIDSON® SOFTAIL								
FXBBS Street Bob 114 *Oversize Rotor Available	2021-2024			FA296HH	EPFA296HH	010	HBK002	1
FXLRS Low Rider S 114 *Oversize Rotor Available	2021-2026			FA296HH*	EPFA296HH*	010	HBK002	2
FLI Hydra-Glide Revival 114 *Oversize Rotor Available	2024			FA296HH	EPFA296HH	010	HBK002	3
FLSB Sport Glide *Oversize Rotor Available	2024			FA296HH	EPFA296HH	010	HBK002	4
FLFBS Fatboy 117 *Oversize Rotor Available	2025-2026			FA296HH	EPFA296HH	010	HBK002	5
FXLRST Low Rider ST 117 *Oversize Rotor Available	2022-2026			FA296HH*	EPFA296HH*	010	HBK002	6
FXLRT Low Rider EL Diablo 117 *Oversize Rotor Available	2022-2023			FA296HH*	EPFA296HH*	010	HBK002	7
FXLRST Tobacco Fade Low Rider ST 117 *Oversize Rotor Available	2024-2025			FA296HH*	EPFA296HH*	010	HBK002	8
FLHC Heritage Classic 117	2025-2026			FA296HH	EPFA296HH	010	HBK002	9
FXBBS Street Bob 117	2025-2026			FA296HH	EPFA296HH	010	HBK002	10
FXBR Breakout 117 *Oversize Rotor Available	2025-2026			FA296HH	EPFA296HH	010	HBK002	11
FXLRS Low Rider S 117	2025-2026			FA296HH*	EPFA296HH*	010	HBK002	12
FXLRST Low Rider ST 117 *Oversize Rotor Available	2025-2026			FA296HH*	EPFA296HH*	010	HBK002	13
FLFBS Fatboy Gray Ghost 117 *Oversize Rotor Available	2026			FA296HH	EPFA296HH	010	HBK002	14
HARLEY-DAVIDSON® TOURING								
FLT, FLHT, FLHTCI Ultraglide®/Electraglide®/Electraglide Classic®/Ultra Classic® Banana Caliper	1980-1983		FA72V*					17
FLT, FLHT, FLHTCI Ultraglide®/Electraglide®/Electraglide Classic®/Ultra Classic® Hayes Caliper	1984-1985	FA94*	FA94V*	FA94HH*	EPFA94HH*			18
FLT, FLHT, FLHTCI Ultraglide®/Electraglide®/Electraglide Classic®/Ultra Classic® Hayes Caliper	1986-1993	FA94*	FA94V*	FA94HH*	EPFA94HH*	002	HBK001	19
FLHR, FLHRCi Road King®, Road King Classic®	1994-1999	FA94*	FA94V*	FA94HH*	EPFA94HH*	002	HBK001	20
FLT, FLHT, FLHTCI Ultraglide®/Electraglide®/Electraglide Classic®/Ultra Classic® Hayes Caliper	1994-1999	FA94*	FA94V*	FA94HH*	EPFA94HH*	002	HBK001	21
FLHR Road King *Oversize Rotor Available	2000-2007	FA400*	FA400V*	FA400HH*	EPFA400HH*	001	HBK002	22
FLHRCi Road King Classic *Oversize Rotor Available	2000-2007	FA400*	FA400V*	FA400HH*	EPFA400HH*	001	HBK002	23
FLHT Electra Glide Standard *Oversize Rotor Available	2000-2007	FA400*	FA400V*	FA400HH*	EPFA400HH*	001	HBK002	24
FLHTC Electra Glide Classic *Oversize Rotor Available	2000-2007	FA400*	FA400V*	FA400HH*	EPFA400HH*	001	HBK002	25
FLHTCU-I Electra Glide Ultra Classic *Oversize Rotor Available	2000-2007	FA400*	FA400V*	FA400HH*	EPFA400HH*	001	HBK002	26
FLHX/FLHXi Street Glide *Oversize Rotor Available	2000-2007	FA400*	FA400V*	FA400HH*	EPFA400HH*	001	HBK002	27
FLHRS Road King Custom *Oversize Rotor Available	2004-2007	FA400*	FA400V*	FA400HH*	EPFA400HH*	001	HBK002	28
FLHTK Electra Glide Ultra Limited	2010-2013	FA409*	FA409V*	FA409HH*	EPFA409HH*	010	HBK002	29
FLHR Road King 96 *Oversize Rotor Available	2008-2011	FA409*	FA409V*	FA409HH*	EPFA409HH*	010	HBK002	30
FLHRC Road King Classic 96 *Oversize Rotor Available	2008-2010	FA409*	FA409V*	FA409HH*	EPFA409HH*	010	HBK002	31
FLHT Electra Glide Standard 96 *Oversize Rotor Available	2008-2010	FA409*	FA409V*	FA409HH*	EPFA409HH*	010	HBK002	32
FLHTC Electra Glide Classic 96 *Oversize Rotor Available	2008-2011	FA409*	FA409V*	FA409HH*	EPFA409HH*	010	HBK002	33
FLHTCU Electra Glide Ultra Classic 96 *Oversize Rotor Available	2008-2010	FA409*	FA409V*	FA409HH*	EPFA409HH*	010	HBK002	34
FLHX Street Glide 96 *Oversize Rotor Available	2008-2011	FA409*	FA409V*	FA409HH*	EPFA409HH*	010	HBK002	35
FLTR Road Glide *Oversize Rotor Available	2008-2009	FA409*	FA409V*	FA409HH*	EPFA409HH*	010	HBK002	36
FLTRX Road Glide Custom *Oversize Rotor Available	2010-2012	FA409*	FA409V*	FA409HH*	EPFA409HH*	010	HBK002	37
HARLEY-DAVIDSON® GRAND AMERICAN TOURING								
FLHTK Electra Glide Ultra LTD *Oversize Rotor Available	2010-2013	FA409*	FA409V*	FA409HH*	EPFA409HH*	010	HBK002	40
FLHRC Road King Classic 103 *Oversize Rotor Available	2011-2016	FA409*	FA409V*	FA409HH*	EPFA409HH*	010	HBK002	41
FLHTCU Electra Glide Ultra Classic 103 *Oversize Rotor Available	2011-2013	FA409*	FA409V*	FA409HH*	EPFA409HH*	010	HBK002	42
FLTRU Road Glide Ultra *Oversize Rotor Available	2011-2013	FA409*	FA409V*	FA409HH*	EPFA409HH*	010	HBK002	43
FLHR Road King 103 *Oversize Rotor Available	2012-2013	FA409*	FA409V*	FA409HH*	EPFA409HH*	010	HBK002	44
FLHTC Electra Glide Classic 103 *Oversize Rotor Available	2012-2013	FA409*	FA409V*	FA409HH*	EPFA409HH*	010	HBK002	45
FLHRC Road King Classic 103	2014-2016	FA409*	FA409V*	FA409HH*	EPFA409HH*	017	HBK002	46
FLHTCU Electra Glide Ultra Classic	2014-2016	FA409*	FA409V*	FA409HH*	EPFA409HH*	017	HBK002	47
FLHX Street Glide	2014-2026	FA409*	FA409V*	FA409HH*	EPFA409HH*	017	HBK002	48
FLHTCUL Electra Glide Ultra Classic Low	2015-2016	FA409*	FA409V*	FA409HH*	EPFA409HH*	017	HBK002	49
FLHTKL Electra Glide Ultra LTD Low	2015-2016	FA409*	FA409V*	FA409HH*	EPFA409HH*	017	HBK002	50
FLTRX Road Glide	2015-2026	FA409*	FA409V*	FA409HH*	EPFA409HH*	017	HBK002	51
FLTRXS Road Glide Special	2015-2018	FA409*	FA409V*	FA409HH*	EPFA409HH*	017	HBK002	52
FLTRU Road Glide Ultra	2016	FA409*	FA409V*	FA409HH*	EPFA409HH*	017	HBK002	53
FLHR Road King	2014-2016	FA409*	FA409V*	FA409HH*	EPFA409HH*	017	HBK002	54
FLHR Road King	2015-2022	FA409*	FA409V*	FA409HH*	EPFA409HH*	017	HBK002	55

* symbol after part# = 2 pieces required i.e. 2 pad sets or 2 rotors (twin rotor models)

*Oversize Rotor Available - see buyer's guide

FRONT: AMERICAN PRODUCED MOTORCYCLES



SUFFIX OR PREFIX
PAD MATERIALS AND DESCRIPTION

		FRONT						Line #
		PADS	PADS	PADS	PADS	FRONT ROTOR OPTIONS	BOLTS	
		FA	V	HH	EPFA	DESIGN NO.	HBK No.	
		Organic Pads	Semi-Sintered V-Pads™	Double-H™ USA-Made Sintered Pads	Premium Low Noise Street Sintered Pads	See Buyers Guide for rotor style & finish options. Part nos for ordering & sizing.	Rotor Bolt Kits	
HARLEY-DAVIDSON® GRAND AMERICAN TOURING	YEAR							
FLHXS Street Glide Special	2015-2017	FA409*	FA409V*	FA409HH*	EPFA409HH*	017		1
FLHXS Street Glide Special	2015-2017	FA409*	FA409V*	FA409HH*	EPFA409HH*	017		2
FLHRC Road King Classic 107	2017-2019	FA409*	FA409V*	FA409HH*	EPFA409HH*	017		3
FLHTCU Electra Glide Ultra Classic	2017-2019	FA409*	FA409V*	FA409HH*	EPFA409HH*	017		4
FLHTK Electra Glide Ultra Limited	2017-2021	FA409*	FA409V*	FA409HH*	EPFA409HH*	017		5
FLHTK Electra Glide Ultra Limited Shrine Edition	2017-2021	FA409*	FA409V*	FA409HH*	EPFA409HH*	017		6
FLHTKL Electra Glide Ultra Limited Low	2017-2019	FA409*	FA409V*	FA409HH*	EPFA409HH*	017		7
FLTRU Road Glide Ultra	2017-2019	FA409*	FA409V*	FA409HH*	EPFA409HH*	017		8
FLTRXS Road Glide Special *Oversize Rotor Available	2017-2018	FA409*	FA409V*	FA409HH*	EPFA409HH*	017		9
FLHXS Street Glide Special	2018-2023	FA409*	FA409V*	FA409HH*	EPFA409HH*	017		10
FLHT Electra Glide Standard	2020-2022	FA409*	FA409V*	FA409HH*	EPFA409HH*	017		11
FLTRK Road Glide Limited	2026	FA409*	FA409V*	FA409HH*	EPFA409HH*	017		12
FLH Revival *Oversize Rotor Available	2021	FA409*	FA409V*	FA409HH*	EPFA409HH*	017		13
FLHXST Street Glide ST 107	2026	FA409*	FA409V*	FA409HH*	EPFA409HH*	017		14
FLHRXS Road King Special 114	2017-2024	FA409*	FA409V*	FA409HH*	EPFA409HH*	017		15
FLTRXS Road Glide Special 114-3	2019-2023	FA409*	FA409V*	FA409HH*	EPFA409HH*	017		16
FLTRK Road Glide Limited 114	2020-2026	FA409*	FA409V*	FA409HH*	EPFA409HH*	017		17
FLHXST Street Glide Special ST	2022	FA409*	FA409V*	FA409HH*	EPFA409HH*	017		18
FLTRXST Road Glide Special ST	2022	FA409*	FA409V*	FA409HH*	EPFA409HH*	017		19
FLHRXS Road King Special 114	2024-2026	FA409*	FA409V*	FA409HH*	EPFA409HH*	017		20
FLHTK Electra Glide Tobacco Fade Ultra LTD 114	2024-2025	FA409*	FA409V*	FA409HH*	EPFA409HH*	017		21
FLHTK Electra Glide Ultra LTD 114	2024	FA409*	FA409V*	FA409HH*	EPFA409HH*	017		22
FLHXST Street Glide ST 117	2026	FA409*	FA409V*	FA409HH*	EPFA409HH*	017		23
FLTRXST Road Glide ST	2023	FA409*	FA409V*	FA409HH*	EPFA409HH*	017		24
FLTRX Road Glide ST	2022-2026	FA409*	FA409V*	FA409HH*	EPFA409HH*	017		25
FLHX Street Glide 117	2024-2026	FA409*	FA409V*	FA409HH*	EPFA409HH*			26
FLTRX Road Glide 117	2024-2026	FA409*	FA409V*	FA409HH*	EPFA409HH*			27
FLHXU Street Glide Ultra 117	2025-2026	FA409*	FA409V*	FA409HH*	EPFA409HH*	017		28
								29
								30
HARLEY-DAVIDSON® TRIKE								
FLHTCUTG Tri Glide Ultra Classic Trike	2009-2013	FA409*	FA409V*	FA409HH*	EPFA409HH*	010	HBK002	31
FLHXXX Street Glide Trike	2010-2013	FA409*	FA409V*	FA409HH*	EPFA409HH*	010	HBK002	32
FLHTCUTG Tri Glide Ultra	2014-2019	FA638*	FA638V*	FA638HH*	EPFA638HH*	010	HBK002	33
FLRT Freewheeler Trike	2015-2019	FA638*	FA638V*	FA638HH*	EPFA638HH*	010	HBK002	34
FLHTCUTG Tri Glide Ultra	2020-2026	FA638*	FA638V*	FA638HH*	EPFA638HH*	010	HBK002	35
FLRT Freewheeler Trike	2020-2026	FA638*	FA638V*	FA638HH*	EPFA638HH*	010	HBK002	36
FLRT Road Glide 3 Trike 114	2023-2026	FA409*	FA409V*	FA409HH*	EPFA409HH*	010	HBK002	37
FLHTCUTG Tobacco Fade Tri Glide Ultra 114	2024	FA638*	FA638V*	FA638HH*	EPFA638HH*	010	HBK002	38
FLHTCUTGSE Tri Glide CVO 117 *Oversize Rotor Available	2020	FA409*	FA409V*	FA409HH*	EPFA409HH*			39
FLHTCUTGSE CVO Tri Glide	2021-2023	FA409*	FA409V*	FA409HH*	EPFA409HH*	010	HBK002	40
								41
								42
HARLEY-DAVIDSON® CVO								
FLHTKSE CVO Limited	2016	FA409*	FA409V*	FA409HH*	EPFA409HH*			43
FLHXSE CVO Street Glide	2016	FA409*	FA409V*	FA409HH*	EPFA409HH*	007		44
FLTRUSE 1TAN CVO Road Glide Ultra	2016	FA409*	FA409V*	FA409HH*	EPFA409HH*			45
FXSE 1TG9 CVO Pro Street Breakout	2016			FA296HH*	EPFA296HH*	007		46
FLHTKSE ANV CVO Ultra Limited 117 *Oversize Rotor Available	2018	FA409*	FA409V*	FA409HH*	EPFA409HH*			47
FLHTKSE ANV CVO Ultra Limited Anniversary 117 *Oversize Rotor Available	2018	FA409*	FA409V*	FA409HH*	EPFA409HH*			48
FLHXSE CVO Street Glide *Oversize Rotor Available	2018-2019	FA409*	FA409V*	FA409HH*	EPFA409HH*	010	HBK002	49
FLTRXSE CVO Road Glide 117 *Oversize Rotor Available	2018-2023	FA409*	FA409V*	FA409HH*	EPFA409HH*	010	HBK002	50
FLHTKSE Ultra Limited CVO 117 *Oversize Rotor Available	2020	FA409*	FA409V*	FA409HH*	EPFA409HH*	010	HBK002	51
FLHXSE Street Glide CVO 117 *Oversize Rotor Available	2020	FA409*	FA409V*	FA409HH*	EPFA409HH*	010	HBK002	52
FLHTKSE CVO Ultra Limited	2021-2023	FA409*	FA409V*	FA409HH*	EPFA409HH*	017		53
FLHXSE CVO Street Glide	2021-2026	FA409*	FA409V*	FA409HH*	EPFA409HH*	017		54
FLTRKSE CVO Road Glide Limited	2022-2023	FA409*	FA409V*	FA409HH*	EPFA409HH*	017		55

* symbol after part# = 2 pieces required i.e. 2 pad sets or 2 rotors (twin rotor models)

**Oversize Rotor Available - see buyer's guide

REAR: AMERICAN PRODUCED MOTORCYCLES



SUFFIX OR PREFIX
PAD MATERIALS AND DESCRIPTION

		REAR					
		PADS	PADS	PADS	PADS	REAR ROTOR OPTIONS	BOLTS
		FA	V	HH	EPFA	DESIGN NO.	HBK No.
		Organic Pads	Semi- Sintered V-Pads™	Double-H™ USA-Made Sintered Pads	Premium Low Noise Street Sintered Pads	See Buyers Guide for rotor style & finish options. Part nos for ordering & sizing.	Rotor Bolt Kits
Line #	HARLEY-DAVIDSON® CVO						
1	FLHXSE CVO Street Glide 121	2023-2026	FA409	FA409V	FA409HH	EPFA409HH	009
2	FLTRXSE CVO Road Glide 121	2023-2026	FA409	FA409V	FA409HH	EPFA409HH	009
3	FLTRXSTSE Road Glide ST CVO 121	2024-2026	FA409	FA409V	FA409HH	EPFA409HH	009
4	FLTRXRRSE Road Glide CVO 131	2025-2026	FA409	FA409V	FA409HH	EPFA409HH	009
5							
6	HARLEY-DAVIDSON® V-ROD						
7	VRSCA	2002-2005	FA400	FA400V	FA400HH	EPFA400HH	
8	VRSCB	2004-2005	FA400	FA400V	FA400HH	EPFA400HH	
9	VRSCA	2006	FA409	FA409V	FA409HH	EPFA409HH	008
10	VRSCD Night Rod	2006-2008	FA409	FA409V	FA409HH	EPFA409HH	008
11	VRSCR Street Rod	2006-2007	FA409	FA409V	FA409HH	EPFA409HH	008
12	VRSCAW	2007	FA409	FA409V	FA409HH	EPFA409HH	008
13	VRSCDX Night Rod Special inc 105 model	2007-2017	FA409	FA409V	FA409HH	EPFA409HH	008
14	VRSCX Screaming Eagle V-Rod	2007	FA409	FA409V	FA409HH	EPFA409HH	008
15	VRSCAW	2008-2010	FA409	FA409V	FA409HH	EPFA409HH	008
16	VRSCF Muscle inc 105 model	2009-2017	FA409	FA409V	FA409HH	EPFA409HH	014
17	VRSCDX Night Rod Special Ann	2012	FA409	FA409V	FA409HH	EPFA409HH	008
18							
19							
20							
21							
22							
23							
24							
25							
26							
27							
28							
29							
30							
31							
32							
33							
34							
35							
36							
37							
38							
39							
40							
41							
42							
43							
44							
45							
46							
47							
48							
49							
50							
51							
52							
53							
54							
55							

All names & numbers are for reference purposes only. © Registered trademarks of Harley—Davidson® Motor Corp or Buell. NOTE: — Some models may have a second rotor fitted as an optional extra. Please double check with your customer exactly which side the front rotor is fitted and if twin rotor or single.

* symbol after part# = 2 pieces required i.e. 2 pad sets or 2 rotors (twin rotor models)

Part numbers, prefixes, suffixes, photos and illustrations shown in this catalog are trademarks and/or copyrights of EBC Brakes or the trademark owner A C Freeman Investments Ltd and use without express written permission of the owners is punishable by law.

FRONT: AMERICAN PRODUCED MOTORCYCLES



SUFFIX OR PREFIX
PAD MATERIALS AND DESCRIPTION

	YEAR	FRONT				FRONT ROTOR OPTIONS	Line #
		PADS	PADS	PADS	PADS	DESIGN NO.	
		FA	V	HH	EPFA		
ARCH		Organic Pads	Semi-Sintered V-Pads™	Double-H™ USA-Made Sintered Pads	Premium Low Noise Street Sintered Pads	See Buyers Guide for rotor style & finish options. Part nos for ordering & sizing.	
1 S	2019-2022	FA175*		FA175HH*	EPFA175HH*		1
KRGT-1	2019-2021	FA175*		FA175HH*	EPFA175HH*		2
Method 143	2019-2021	FA175*		FA175HH*	EPFA175HH*		3
ATK							4
125	2003	FA181X		FA181R			5
250	2004	FA181X		FA181R		MD6032D	6
GT 250 R V-Twin Sport	2011	FA86*		FA86HH*		MD690*	7
GV 250 V-Twin Cruiser	2011	FA86		FA86HH			8
250/260	2003	FA181X		FA181R			9
370	2004	FA181X		FA181R		MD6032D	10
450 Enduro	2007	FA181X		FA181R			11
450 Motard	2007	FA95		FA95HH	EPFA95HH		12
450 MX	2007	FA181X		FA181R			13
450 XC	2007	FA181X		FA181R			14
500 Enduro	2003-2004	FA181X		FA181R			15
500 Enduro	2004	FA181X		FA181R		MD6032D	16
560	1984-1986	FA47X					17
560	1987-1988	FA47X					18
560	1989-1991	FA126X					19
All models	1992	FA126X					20
All models	1993-1996	FA135X		FA135R			21
All models	1997-1999	FA181X		FA181R	EPFA181HH		22
500/600 Super Motard	2002-2003	FA95		FA95HH	EPFA95HH		23
600 DTM Dirt Track Motard	2003	FA95		FA95HH	EPFA95HH		24
605 Enduro	2003	FA181X		FA181R	EPFA181HH		25
620 Intimidator	2004	FA181X		FA181R		MD6032D	26
650 GT R V-Twin Sport	2011	FA86*		FA86HH*		MD690*	27
650 GV V-Twin Cruiser	2011	FA86*		FA86HH*		MD691*	28
700 Intimidator	2004-2005	FA181X		FA181R		MD6032D	29
BUELL							30
Blast	2000-2007	FA196	FA196V	FA196HH	EPFA196HH	MD737	31
Firebolt XB9R	2002-2006			FA345HH	EPFA345HH	MD735RS	32
S1 Lightning	1994-1997	FA210				MD719RS	33
S1 Lightning	1998-2000	FA424		FA424HH		MD719RS	34
S1 White Lightning AE	1998-2000	FA424		FA424HH		MD719RS	35
X1 Lightning AE	1998-2000	FA424		FA424HH		MD719RS	36
X1 Lightning AE	2000-2005	FA424		FA424HH		MD734RS	37
1125 R/CR R	2008-2009			FA454/4HH	EPFA454/4HH	MD735RS	38
M2 Cyclone	1994-1997	FA210				MD719RS	39
S2 Thunderbolt	1994-1997	FA210				MD719RS	40
M2 Cyclone	1998-2000	FA424		FA424HH		MD719RS	41
S3 Thunderbolt AE	1998-2000	FA424		FA424HH		MD719RS	42
M2 Cyclone AE	2000-2005	FA424		FA424HH		MD734RS	43
XB9S Lightning	2003-2004			FA345HH	EPFA345HH	MD735RS	44
XB12 R Firebolt	2004-2007			FA345HH	EPFA345HH	MD735RS	45
XB9SX Lightning	2004-2009			FA345HH	EPFA345HH	MD735RS	46
XB9SX Lightning City X	2005-2009			FA345HH	EPFA345HH	MD735RS	47
XB12 S Ulysses	2006-2009			FA345HH	EPFA345HH	MD735RS	48
XB12 SCG Lightning	2006-2008			FA345HH	EPFA345HH	MD735RS	49
XB12 Ss Lightning Long	2006-2008			FA345HH	EPFA345HH	MD735RS	50
XB12 XT Ulysses	2008-2009			FA345HH	EPFA345HH	MD735RS	51
XB12 R Firebolt	2009-2009			FA454/4HH	EPFA454/4HH	MD735RS	52
XB12 Ss Lightning	2009-2009			FA454/4HH	EPFA454/4HH	MD735RS	53

* symbol after part# = 2 pieces required i.e. 2 pad sets or 2 rotors (twin rotor models)

FRONT: AMERICAN PRODUCED MOTORCYCLES



SUFFIX OR PREFIX
PAD MATERIALS AND DESCRIPTION

YEAR

					FRONT				FRONT ROTOR OPTIONS
					PADS	PADS	PADS	PADS	DESIGN NO.
					FA	V	HH	EPFA	
					Organic Pads	Semi-Sintered V-Pads™	Double-H™ USA-Made Sintered Pads	Premium Low Noise Street Sintered Pads	See Buyers Guide for rotor style & finish options. Part nos for ordering & sizing.
BUELL									
XB12 STT Lightning			2009-2009				FA454/4HH	EPFA454/4HH	MD735RS
CAN AM CANYON									
Canyon			2025			FA630V*	FA630HH*	EPFA630HH*	MD853*
Canyon Redrock			2025-2026			FA630V*	FA630HH*	EPFA630HH*	MD853*
Canyon XT			2025-2026			FA630V*	FA630HH*	EPFA630HH*	MD853*
CAN AM RYKER									
600 Ace	Left		2018-2024		FA165X		FA165R		
600 Ace	Right		2018-2024		FA135X		FA135R		
900 Ace	Left		2018-2024		FA165X		FA165R		
900 Ace	Right		2018-2024		FA135X		FA135R		
900 Ace Rally Edition	Left		2021-2024		FA165X		FA165R		
900 Ace Rally Edition	Right		2021-2024		FA135X		FA135R		
900 Sport	Left		2025		FA165X		FA165R		
900 Sport	Right		2025		FA135X		FA135R		
CAN AM SPYDER									
RS SE5			2008-2009		FA474*	FA474V*			MD801*
RS SM5			2008-2009		FA474*	FA474V*			MD801*
RS Phantom Black			2009		FA474*	FA474V*			MD801*
RS			2010-2012		FA474*	FA474V*			MD801*
RS-S			2010-2012		FA474*	FA474V*			MD801*
RT			2010-2012		FA474*	FA474V*			MD801*
RT LTD			2010-2012		FA474*	FA474V*			MD801*
RT-S			2010-2012		FA474*	FA474V*			MD801*
RS			2013-2016			FA630V*	FA630HH*	EPFA630HH*	MD853*
RS-S			2013-2016			FA630V*	FA630HH*	EPFA630HH*	MD853*
RT			2013-2024			FA630V*	FA630HH*	EPFA630HH*	MD853*
RT LTD			2013-2021			FA630V*	FA630HH*	EPFA630HH*	MD853*
RT-S			2013-2015			FA630V*	FA630HH*	EPFA630HH*	MD853*
ST			2013-2016			FA630V*	FA630HH*	EPFA630HH*	MD853*
ST LTD			2013-2015			FA630V*	FA630HH*	EPFA630HH*	MD853*
ST-S			2013-2016			FA630V*	FA630HH*	EPFA630HH*	MD853*
F3 SE6ISM6			2015-2025			FA630V*	FA630HH*	EPFA630HH*	MD853*
F3-S SE6ISM6			2015-2021			FA630V*	FA630HH*	EPFA630HH*	MD853*
F3 LTD			2016-2025			FA630V*	FA630HH*	EPFA630HH*	MD853*
F3-S Special Series			2016-2023			FA630V*	FA630HH*	EPFA630HH*	MD853*
F3-T			2016-2025			FA630V*	FA630HH*	EPFA630HH*	MD853*
RT-S Special Series			2016-2017			FA630V*	FA630HH*	EPFA630HH*	MD853*
F3-S Daytona 500			2017			FA630V*	FA630HH*	EPFA630HH*	MD853*
F3 LTD Special Series			2023-2025			FA630V*	FA630HH*	EPFA630HH*	MD853*
EBR									
1190 RS Sport			2014-2015				FA454/4HH	EPFA454/4HH	MD735RS
1190 RX Sport			2014-2015				FA454/4HH	EPFA454/4HH	MD735RS
1190 SX			2014-2015				FA454/4HH	EPFA454/4HH	MD735RS
INDIAN									
Scout Sixty			2016		FA672	FA672V	FA672HH	EPFA672HH	MD534
Scout Sixty			2017-2026		FA209/2	FA209/2V	FA209/2HH	EPFA209/2HH	MD534
Scout Sixty Bobber			2021-2024		FA209/2	FA209/2V	FA209/2HH	EPFA209/2HH	MD534
Scout Rogue Sixty			2023-2024		FA209/2	FA209/2V	FA209/2HH	EPFA209/2HH	MD534
Scout			2015-2016		FA672	FA672V	FA672HH	EPFA672HH	MD534
Scout			2017-2024		FA209/2	FA209/2V	FA209/2HH	EPFA209/2HH	MD534

Line #

* symbol after part# = 2 pieces required i.e. 2 pad sets or 2 rotors (twin rotor models)

REAR: AMERICAN PRODUCED MOTORCYCLES



SUFFIX OR PREFIX
PAD MATERIALS AND DESCRIPTION

YEAR

REAR

PADS

PADS

PADS

PADS

REAR ROTOR
OPTIONS

FA

V

HH

EPFA

DESIGN NO.

Organic
Pads

Semi-Sintered
V-Pads™

Double-H™
USA-Made
Sintered Pads

Premium Low
Noise Street
Sintered Pads

See Buyers Guide for
rotor style & finish
options. Part nos for
ordering & sizing.

Line #

BUELL

1 XB12 STT Lightning

2009-2009

FA140

FA140V

FA140HH

MD522

CAN AM CANYON

4 Canyon

2025

FA631HH

MD854

5 Canyon Redrock

2025-2026

FA631HH

MD854

6 Canyon XT

2025-2026

FA631HH

MD854

CAN AM RYKER

9 600 Ace

Left 2018-2024

FA317X

SXR317HH

FA317R

10 600 Ace

Right 2018-2024

11 900 Ace

Left 2018-2024

FA317X

SXR317HH

FA317R

12 900 Ace

Right 2018-2024

13 900 Ace Rally Edition

Left 2021-2024

FA317X

SXR317HH

FA317R

14 900 Ace Rally Edition

Right 2021-2024

15 900 Sport

Left 2025

FA317X

SXR317HH

FA317R

16 900 Sport

Right 2025

CAN AM SPYDER

19 RS SE5

2008-2009

FA473

FA473V

MD802

20 RS SM5

2008-2009

FA473

FA473V

MD802

21 RS Phantom Black

2009

FA473

FA473V

MD802

22 RS

2010-2012

FA473

FA473V

MD802

23 RS-S

2010-2012

FA473

FA473V

MD802

24 RT

2010-2012

FA473

FA473V

MD802

25 RT LTD

2010-2012

FA473

FA473V

MD802

26 RT-S

2010-2012

FA473

FA473V

MD802

27 RS

2013-2016

FA631V

FA631HH

MD854

28 RS-S

2013-2016

FA631V

FA631HH

MD854

29 RT

2013-2024

FA631V

FA631HH

MD854

30 RT LTD

2013-2021

FA631V

FA631HH

MD854

31 RT-S

2013-2015

FA631V

FA631HH

MD854

32 ST

2013-2016

FA631V

FA631HH

MD854

33 ST LTD

2013-2015

FA631V

FA631HH

MD854

34 ST-S

2013-2016

FA631V

FA631HH

MD854

35 F3 SE6ISM6

2015-2025

FA631V

FA631HH

MD854

36 F3-S SE6ISM6

2015-2021

FA631V

FA631HH

MD854

37 F3 LTD

2016-2025

FA631V

FA631HH

MD854

38 F3-S Special Series

2016-2023

FA631V

FA631HH

MD854

39 F3-T

2016-2025

FA631V

FA631HH

MD854

40 RT-S Special Series

2016-2017

FA631V

FA631HH

MD854

41 F3-S Daytona 500

2017

FA631V

FA631HH

MD854

42 F3 LTD Special Series

2023-2025

FA631V

FA631HH

MD854

EBR

45 1190 RS Sport

2014-2015

FA460HH

46 1190 RX Sport

2014-2015

FA460HH

47 1190 SX

2014-2015

FA460HH

INDIAN

50 Scout Sixty

2016

FA377X

FA377V

MD534

51 Scout Sixty

2017-2026

FA213

FA213V

FA213HH

EPFA213HH

MD534

52 Scout Sixty Bobber

2021-2024

FA213

FA213V

FA213HH

EPFA213HH

MD534

53 Scout Rogue Sixty

2023-2024

FA213

FA213V

FA213HH

EPFA213HH

MD534

54 Scout

2015-2016

FA377X

FA377V

MD534

55 Scout

2017-2024

FA213

FA213V

FA213HH

EPFA213HH

MD534

* symbol after part# = 2 pieces required i.e. 2 pad sets or 2 rotors (twin rotor models)

Part numbers, prefixes, suffixes, photos and illustrations shown in this catalog are trademarks and/or copyrights of EBC Brakes or the trademark owner A C Freeman Investments Ltd and use without express written permission of the owners is punishable by law.

All names & numbers are for reference purposes only. © Registered trademarks of Harley—Davidson® Motor Corp or Buell.

NOTE: — Some models may have a second rotor fitted as an optional extra. Please double check with your customer exactly which side the front rotor is fitted and if twin rotor or single.

FRONT: AMERICAN PRODUCED MOTORCYCLES



SUFFIX OR PREFIX
PAD MATERIALS AND DESCRIPTION

YEAR

		FRONT				FRONT ROTOR OPTIONS
		PADS	PADS	PADS	PADS	DESIGN NO.
		FA	V	HH	EPFA	
		Organic Pads	Semi-Sintered V-Pads™	Double-H™ USA-Made Sintered Pads	Premium Low Noise Street Sintered Pads	See Buyers Guide for rotor style & finish options. Part nos for ordering & sizing.
Scout Bobber	2019-2024	FA209/2	FA209/2V	FA209/2HH	EPFA209/2HH	
Scout Bobber Twenty	2019-2024	FA209/2	FA209/2V	FA209/2HH	EPFA209/2HH	
Scout Rogue	2022-2024	FA209/2	FA209/2V	FA209/2HH	EPFA209/2HH	MD534
FTR 1200	2018-2026			FA630HH*	EPFA630HH*	MD803*
FTR 1200 S	2019-2023			FA630HH*	EPFA630HH*	MD803*
FTR 1200 S Race Replica	2019-2020			FA630HH*	EPFA630HH*	MD803*
FTR 1200 Rally	2020-2025			FA630HH*	EPFA630HH*	MD803*
FTR 1200 R Carbon	2021-2026			FA630HH*	EPFA630HH*	MD803*
FTR 1200 Sport	2024-2026			FA630HH*	EPFA630HH*	MD803*
FTR 1200 X All Options	2024-2025			FA630HH*	EPFA630HH*	MD803*
101 Scout	2025-2026		FA630V*	FA630HH*	EPFA630HH*	
Scout Bobber	2025-2026	FA209/2	FA209/2V	FA209/2HH	EPFA209/2HH	
Scout Classic	2025-2026	FA209/2	FA209/2V	FA209/2HH	EPFA209/2HH	
Scout Sixty Bobber	2025-2026	FA209/2	FA209/2V	FA209/2HH	EPFA209/2HH	
Scout Sixty Classic	2025-2026	FA209/2	FA209/2V	FA209/2HH	EPFA209/2HH	
Sport Scout	2025-2026	FA209/2	FA209/2V	FA209/2HH	EPFA209/2HH	
Sport Scout Sixty	2025-2026	FA209/2	FA209/2V	FA209/2HH	EPFA209/2HH	
Super Scout	2025-2026	FA209/2	FA209/2V	FA209/2HH	EPFA209/2HH	
Scout All models	2002-2008	FA216/3	FA216/3V	FA216/3HH		
Spirit All models	2002-2008	FA216/3	FA216/3V	FA216/3HH		
Chief All models	2002-2008	FA216/3	FA216/3V	FA216/3HH		
Chief Deluxe	2009	FA95*	FA95V*	FA95HH*	EPFA95HH*	MD535*
Chief Roadmaster	2009-2011	FA95*	FA95V*	FA95HH*	EPFA95HH*	MD535*
Chief Standard	2009-2011	FA95*	FA95V*	FA95HH*	EPFA95HH*	MD535*
Chief Vintage	2009-2013	FA95*	FA95V*	FA95HH*	EPFA95HH*	MD535*
Bomber	2010-2011	FA95*	FA95V*	FA95HH*	EPFA95HH*	MD535*
Dark Horse	2010-2013	FA95*	FA95V*	FA95HH*	EPFA95HH*	MD535*
Chief Blackhawk	2011	FA95*	FA95V*	FA95HH*	EPFA95HH*	MD535*
Chief Blackhawk Dark	2011	FA95*	FA95V*	FA95HH*	EPFA95HH*	MD535*
Chief Classic	2011-2013	FA95*	FA95V*	FA95HH*	EPFA95HH*	MD535*
Chief Vintage	2014-2017			FA347HH*	EPFA347HH*	MD890BLK*
Pursuit Limited	2022-2024			FA630HH*	EPFA630HH*	MD803*
Pursuit Dark Horse	2023-2024			FA630HH*	EPFA630HH*	MD803*
Pursuit Elite	2023			FA630HH*	EPFA630HH*	MD803*
Challenger 1800	2020-2026			FA630HH*	EPFA630HH*	
Challenger 1800 Dark Horse	2020-2026			FA630HH*	EPFA630HH*	
Challenger 1800 Limited	2020-2026			FA630HH*	EPFA630HH*	
Challenger 1800 Elite	2023-2026			FA630HH*	EPFA630HH*	
Chief Classic	2014-2017			FA347HH*	EPFA347HH*	
Chieftain	2014-2021			FA347HH*	EPFA347HH*	MD890BLK*
Chieftain Dark Horse	2014-2015			FA347HH*	EPFA347HH*	MD890BLK*
Chieftain Elite	2014-2019			FA347HH*	EPFA347HH*	MD890BLK*
Chieftain Limited	2014-2019			FA347HH*	EPFA347HH*	MD890BLK*
Roadmaster	2015-2018			FA347HH*	EPFA347HH*	MD890BLK*
Roadmaster Dark Horse	2015-2019			FA347HH*	EPFA347HH*	MD890BLK*
Roadmaster Elite	2015-2019			FA347HH*	EPFA347HH*	MD890BLK*
Roadmaster Limited	2015-2019			FA347HH*	EPFA347HH*	MD890BLK*
Chief Dark Horse	2016-2020			FA347HH	EPFA347HH	MD890BLK
Springfield	2016-2019			FA347HH*	EPFA347HH*	MD890BLK*
Chief Vintage	2018-2021			FA347HH*	EPFA347HH*	MD890BLK*
Chieftain Dark Horse	2016-2024			FA347HH*	EPFA347HH*	MD890BLK*
Roadmaster	2019-2026			FA347HH*	EPFA347HH*	MD890BLK*
Springfield Dark Horse	2019-2025			FA347HH*	EPFA347HH*	MD890BLK*
Roadmaster Dark Horse	2020-2026			FA347HH*	EPFA347HH*	MD890BLK*
Roadmaster Elite	2020-2026			FA347HH*	EPFA347HH*	MD890BLK*

Line #

* symbol after part# = 2 pieces required i.e. 2 pad sets or 2 rotors (twin rotor models)

REAR: AMERICAN PRODUCED MOTORCYCLES



SUFFIX OR PREFIX
PAD MATERIALS AND DESCRIPTION

Line #	INDIAN	YEAR	REAR				REAR ROTOR OPTIONS
			PADS	PADS	PADS	PADS	DESIGN NO.
			FA	V	HH	EPFA	See Buyers Guide for rotor style & finish options. Part nos for ordering & sizing.
			Organic Pads	Semi-Sintered V-Pads™	Double-H™ USA-Made Sintered Pads	Premium Low Noise Street Sintered Pads	
1	Scout Bobber	2019-2024	FA213	FA213V	FA213HH	EPFA213HH	MD534
2	Scout Bobber Twenty	2019-2024	FA213	FA213V	FA213HH	EPFA213HH	
3	Scout Rogue	2022-2024	FA213	FA213V	FA213HH	EPFA213HH	MD534
4	FTR 1200	2018-2026	FA266	FA266V	FA266HH	EPFA266HH	MD8007
5	FTR 1200 S	2019-2023	FA266	FA266V	FA266HH	EPFA266HH	MD8007
6	FTR 1200 S Race Replica	2019-2020	FA266	FA266V	FA266HH	EPFA266HH	MD8007
7	FTR 1200 Rally	2020-2025	FA266	FA266V	FA266HH	EPFA266HH	MD8007
8	FTR 1200 R Carbon	2021-2026	FA266	FA266V	FA266HH	EPFA266HH	MD8007
9	FTR 1200 Sport	2024-2026	FA266	FA266V	FA266HH	EPFA266HH	MD8007
10	FTR 1200 X All Options	2024-2025	FA266	FA266V	FA266HH	EPFA266HH	MD8007
11	101 Scout	2025-2026	FA213	FA213V	FA213HH	EPFA213HH	MD534
12	Scout Bobber	2025-2026	FA213	FA213V	FA213HH	EPFA213HH	MD534
13	Scout Classic	2025-2026	FA213	FA213V	FA213HH	EPFA213HH	MD534
14	Scout Sixty Bobber	2025-2026	FA213	FA213V	FA213HH	EPFA213HH	MD534
15	Scout Sixty Classic	2025-2026	FA213	FA213V	FA213HH	EPFA213HH	MD534
16	Sport Scout	2025-2026	FA213	FA213V	FA213HH	EPFA213HH	MD534
17	Sport Scout Sixty	2025-2026	FA213	FA213V	FA213HH	EPFA213HH	MD534
18	Super Scout	2025-2026	FA213	FA213V	FA213HH	EPFA213HH	MD534
19	Scout All models	2002-2008	FA216/3	FA216/3V	FA216/3HH		
20	Spirit All models	2002-2008	FA216/3	FA216/3V	FA216/3HH		
21	Chief All models	2002-2008	FA216/3	FA216/3V	FA216/3HH		
22	Chief Deluxe	2009			FA696HH		MD535
23	Chief Roadmaster	2009-2011			FA696HH		MD535
24	Chief Standard	2009-2011			FA696HH		MD535
25	Chief Vintage	2009-2013			FA696HH		MD535
26	Bomber	2010-2011			FA696HH		MD535
27	Dark Horse	2010-2013			FA696HH		MD535
28	Chief Blackhawk	2011			FA696HH		MD535
29	Chief Blackhawk Dark	2011			FA696HH		MD535
30	Chief Classic	2011-2013			FA696HH		MD535
31	Chief Vintage	2014-2017	FA196	FA196V	FA196HH	EPFA196HH	MD887BLK
32	Pursuit Limited	2022-2024	FA196	FA196V	FA196HH	EPFA196HH	MD887BLK
33	Pursuit Dark Horse	2023-2024	FA196	FA196V	FA196HH	EPFA196HH	MD887BLK
34	Pursuit Elite	2023	FA196	FA196V	FA196HH	EPFA196HH	MD887BLK
35	Challenger 1800	2020-2026	FA196	FA196V	FA196HH	EPFA196HH	
36	Challenger 1800 Dark Horse	2020-2026	FA196	FA196V	FA196HH	EPFA196HH	
37	Challenger 1800 Limited	2020-2026	FA196	FA196V	FA196HH	EPFA196HH	
38	Challenger 1800 Elite	2023-2026	FA196	FA196V	FA196HH	EPFA196HH	
39	Chief Classic	2014-2017	FA196	FA196V	FA196HH	EPFA196HH	
40	Chieftain	2014-2021	FA196	FA196V	FA196HH	EPFA196HH	MD887BLK
41	Chieftain Dark Horse	2014-2015	FA196	FA196V	FA196HH	EPFA196HH	MD887BLK
42	Chieftain Elite	2014-2019	FA196	FA196V	FA196HH	EPFA196HH	MD887BLK
43	Chieftain Limited	2014-2019	FA196	FA196V	FA196HH	EPFA196HH	MD887BLK
44	Roadmaster	2015-2018	FA196	FA196V	FA196HH	EPFA196HH	MD887BLK
45	Roadmaster Dark Horse	2015-2019	FA196	FA196V	FA196HH	EPFA196HH	MD887BLK
46	Roadmaster Elite	2015-2019	FA196	FA196V	FA196HH	EPFA196HH	MD887BLK
47	Roadmaster Limited	2015-2019	FA196	FA196V	FA196HH	EPFA196HH	MD887BLK
48	Chief Dark Horse	2016-2020	FA196	FA196V	FA196HH	EPFA196HH	MD887BLK
49	Springfield	2016-2019	FA196	FA196V	FA196HH	EPFA196HH	MD887BLK
50	Chief Vintage	2018-2021	FA196	FA196V	FA196HH	EPFA196HH	MD887BLK
51	Chieftain Dark Horse	2016-2024	FA196	FA196V	FA196HH	EPFA196HH	MD887BLK
52	Roadmaster	2019-2026	FA196	FA196V	FA196HH	EPFA196HH	MD887BLK
53	Springfield Dark Horse	2019-2025	FA196	FA196V	FA196HH	EPFA196HH	MD887BLK
54	Roadmaster Dark Horse	2020-2026	FA196	FA196V	FA196HH	EPFA196HH	MD887BLK
55	Roadmaster Elite	2020-2026	FA196	FA196V	FA196HH	EPFA196HH	MD887BLK

* symbol after part# = 2 pieces required i.e. 2 pad sets or 2 rotors (twin rotor models)

Part numbers, prefixes, suffixes, photos and illustrations shown in this catalog are trademarks and/or copyrights of EBC Brakes or the trademark owner A C Freeman Investments Ltd and use without express written permission of the owners is punishable by law.

All names & numbers are for reference purposes only. © Registered trademarks of Harley—Davidson® Motor Corp or Buell.
 NOTE: — Some models may have a second rotor fitted as an optional extra. Please double check with your customer exactly which side the front rotor is fitted and if twin rotor or single.

FRONT: AMERICAN PRODUCED MOTORCYCLES



SUFFIX OR PREFIX
PAD MATERIALS AND DESCRIPTION

INDIAN

YEAR	FRONT				FRONT ROTOR OPTIONS	Line #
	PADS	PADS	PADS	PADS	DESIGN NO.	
	FA	V	HH	EPFA		
	Organic Pads	Semi-Sintered V-Pads™	Double-H™ USA-Made Sintered Pads	Premium Low Noise Street Sintered Pads	See Buyers Guide for rotor style & finish options. Part nos for ordering & sizing.	
Roadmaster Limited	2020-2026		FA347HH*	EPFA347HH*	MD890BLK*	1
Springfield 111/116 models	2020-2025		FA347HH*	EPFA347HH*	MD890BLK*	2
Chief Dark Horse	2021-2025		FA347HH	EPFA347HH	MD890BLK	3
Roadmaster Dark Horse Jack Daniel's Edition	2021		FA347HH*	EPFA347HH*	MD890BLK*	4
Chief 111/116 All Options	2022-2026		FA347HH	EPFA347HH	MD890BLK	5
Chief Bobber	2022-2026		FA347HH	EPFA347HH	MD890BLK	6
Chief Bobber Dark Horse	2022-2026		FA347HH	EPFA347HH	MD890BLK	7
Chief Super Chief	2022-2024		FA347HH	EPFA347HH		8
Chief Super Chief Limited	2022-2024		FA347HH	EPFA347HH		9
Chieftain	2022-2026		FA347HH*	EPFA347HH*	MD890BLK*	10
Super Chief Limited 116	2022-2025		FA347HH	EPFA347HH		11
Chieftain Limited	2023-2026		FA347HH*	EPFA347HH*	MD890BLK*	12
Sport Chief 116	2023-2026		FA630HH*	EPFA630HH*	MD803*	13
Chieftain Dark Horse	2025-2026		FA347HH*	EPFA347HH*	MD890BLK*	14
Chieftain PowerPlus All Options	2025-2026		FA347HH*	EPFA347HH*	MD890BLK*	15
Sport Chief RT 116	2025-2026		FA630HH*	EPFA630HH*	MD803*	16
Super Chief Dark Horse	2025		FA347HH	EPFA347HH		17
Chief Super Chief Dark Horse	2026		FA347HH	EPFA347HH		18
Pursuit Dark Horse	2026		FA347HH*	EPFA347HH*	MD890BLK*	19
Pursuit Limited	2026		FA347HH*	EPFA347HH*	MD890BLK*	20
Roadmaster Powerplus Dark Horse	2026		FA347HH*	EPFA347HH*	MD890BLK*	21
Roadmaster Powerplus Limited	2026		FA347HH*	EPFA347HH*	MD890BLK*	22
Super Chief Limited 116	2026		FA347HH	EPFA347HH		23
						24
						25

MOTUS

MST	2014-2017	FA244*	FA244V*	FA244HH*	EPFA244HH*	26
MSTR	2014-2017			FA447HH*	EPFA447HH*	27
MST-01	2012-2013			FA322/4HH*	EPFA322/4HH*	28
MSTR-01	2012-2013			FA322/4HH*	EPFA322/4HH*	29

POLARIS SLINGSHOT

Sport Pad and Sport Rotor Options shown on page 76

						30
						31
						32
						33
Base 2.0L	2015-2017	FA669/4			MD533BSDF	34
SL 2.0L	2015-2024	FA669/4			MD533BSDF	35
SL LE 2.0L	2015-2023	FA669/4			MD533BSDF	36
SLR 2.0L	2017-2024	FA669/4			MD533BSDF	37
S 2.0L	2018-2024	FA669/4			MD533BSDF	38
All SL Models 2.0L	2019-2021	FA669/4			MD533BSDF	39
R 2.0L	2022-2024	FA669/4			MD533BSDF	40
Rouse Edition 2.0L	2023-2024	FA669/4			MD533BSDF	41

VICTORY

						42	
						43	
Empulse TT	2016	FA244*	FA244V*	FA244HH*	EPFA244HH*	MD890BLK*	44
Octane 1200	2017	FA209/2	FA209/2V	FA209/2HH	EPFA209/2HH	MD534	45
Standard Cruiser	1998-2000	FA244	FA244V	FA244HH	EPFA244HH	MD727	46
Deluxe Cruiser	2001-2002	FA244	FA244V	FA244HH	EPFA244HH	MD727	47
Standard Cruiser	2001-2002	FA244	FA244V	FA244HH	EPFA244HH	MD727	48
Touring Cruiser	2003-2006	FA244*	FA244V*	FA244HH*	EPFA244HH*	MD727*	49
Vegas	2003-2007	FA244	FA244V	FA244HH	EPFA244HH	MD678	50
King Pin	2004-2007	FA244	FA244V	FA244HH	EPFA244HH	MD678	51
King Pin Tour	2004-2007	FA244	FA244V	FA244HH	EPFA244HH	MD678	52
Vegas 8-Ball	2005-2007	FA244	FA244V	FA244HH	EPFA244HH	MD678	53
King Pin Tour	2008-2009			FA347HH	EPFA347HH	MD890BLK	54
Hammer	2005-2007	FA244*	FA244V*	FA244HH*	EPFA244HH*	MD678*	55

* symbol after part# = 2 pieces required i.e. 2 pad sets or 2 rotors (twin rotor models)

REAR: AMERICAN PRODUCED MOTORCYCLES



SUFFIX OR PREFIX
PAD MATERIALS AND DESCRIPTION

Line #	INDIAN	YEAR	REAR				REAR ROTOR OPTIONS
			PADS	PADS	PADS	PADS	DESIGN NO.
			FA	V	HH	EPFA	See Buyers Guide for rotor style & finish options. Part nos for ordering & sizing.
			Organic Pads	Semi-Sintered V-Pads™	Double-HTM USA-Made Sintered Pads	Premium Low Noise Street Sintered Pads	
1	Roadmaster Limited	2020-2026	FA196	FA196V	FA196HH	EPFA196HH	MD887BLK
2	Springfield 111/116 models	2020-2025	FA196	FA196V	FA196HH	EPFA196HH	MD887BLK
3	Chief Dark Horse	2021-2025	FA196	FA196V	FA196HH	EPFA196HH	MD887BLK
4	Roadmaster Dark Horse Jack Daniel's Edition	2021	FA196	FA196V	FA196HH	EPFA196HH	MD887BLK
5	Chief 111/116 All Options	2022-2026	FA196	FA196V	FA196HH	EPFA196HH	
6	Chief Bobber	2022-2026	FA196	FA196V	FA196HH	EPFA196HH	
7	Chief Bobber Dark Horse	2022-2026	FA196	FA196V	FA196HH	EPFA196HH	
8	Chief Super Chief	2022-2024	FA196	FA196V	FA196HH	EPFA196HH	
9	Chief Super Chief Limited	2022-2024	FA196	FA196V	FA196HH	EPFA196HH	
10	Chieftain	2022-2026	FA196	FA196V	FA196HH	EPFA196HH	MD887BLK
11	Super Chief Limited 116	2022-2025	FA196	FA196V	FA196HH	EPFA196HH	MD890BLK
12	Chieftain Limited	2023-2026	FA196	FA196V	FA196HH	EPFA196HH	MD887BLK
13	Sport Chief 116	2023-2026	FA196	FA196V	FA196HH	EPFA196HH	MD890BLK
14	Chieftain Dark Horse	2025-2026	FA196	FA196V	FA196HH	EPFA196HH	MD887BLK
15	Chieftain PowerPlus All Options	2025-2026	FA196	FA196V	FA196HH	EPFA196HH	MD887BLK
16	Sport Chief RT 116	2025-2026	FA196	FA196V	FA196HH	EPFA196HH	MD890BLK
17	Super Chief Dark Horse	2025	FA196	FA196V	FA196HH	EPFA196HH	MD890BLK
18	Chief Super Chief Dark Horse	2026	FA196	FA196V	FA196HH	EPFA196HH	
19	Pursuit Dark Horse	2026	FA196	FA196V	FA196HH	EPFA196HH	MD887BLK
20	Pursuit Limited	2026	FA196	FA196V	FA196HH	EPFA196HH	MD887BLK
21	Roadmaster Powerplus Dark Horse	2026	FA196	FA196V	FA196HH	EPFA196HH	MD887BLK
22	Roadmaster Powerplus Limited	2026	FA196	FA196V	FA196HH	EPFA196HH	MD887BLK
23	Super Chief Limited 116	2026	FA196	FA196V	FA196HH	EPFA196HH	MD890BLK
24	MOTUS						
25							
26	MST	2014-2017	FA266	FA266V	FA266HH	EPFA266HH	
27	MSTR	2014-2017	FA266	FA266V	FA266HH	EPFA266HH	
28	MST-01	2012-2013	FA266	FA266V	FA266HH	EPFA266HH	
29	MSTR-01	2012-2013	FA266	FA266V	FA266HH	EPFA266HH	
30	POLARIS SLINGSHOT						
31							
32	Sport Pad and Sport Rotor Options shown on page 76						
33							
34	Base 2.0L	2015-2017	FA670				MD533
35	SL 2.0L	2015-2024	FA670				MD533
36	SL LE 2.0L	2015-2023	FA670				MD533
37	SLR 2.0L	2017-2024	FA670				MD533
38	S 2.0L	2018-2024	FA670				MD533
39	All SL Models 2.0L	2019-2021	FA670				MD533
40	R 2.0L	2022-2024	FA670				MD533
41	Rouse Edition 2.0L	2023-2024	FA670				MD533
42	VICTORY						
43							
44	Empulse TT	2016	FA266	FA266V	FA266HH	EPFA266HH	MD887BLK
45	Octane 1200	2017	FA213	FA213V	FA213HH	EPFA213HH	MD534
46	Standard Cruiser	1998-2000	FA209/2	FA209/2V	FA209/2HH	EPFA209/2HH	MD727
47	Deluxe Cruiser	2001-2002	FA209/2	FA209/2V	FA209/2HH	EPFA209/2HH	MD727
48	Standard Cruiser	2001-2002	FA209/2	FA209/2V	FA209/2HH	EPFA209/2HH	MD727
49	Touring Cruiser	2003-2006	FA209/2	FA209/2V	FA209/2HH	EPFA209/2HH	MD727
50	Vegas	2003-2007	FA209/2	FA209/2V	FA209/2HH	EPFA209/2HH	MD678
51	King Pin	2004-2007	FA209/2	FA209/2V	FA209/2HH	EPFA209/2HH	MD678
52	King Pin Tour	2004-2007	FA209/2	FA209/2V	FA209/2HH	EPFA209/2HH	MD678
53	Vegas 8-Ball	2005-2007	FA209/2	FA209/2V	FA209/2HH	EPFA209/2HH	MD678
54	King Pin Tour	2008-2009	FA196	FA196V	FA196HH	EPFA196HH	MD890BLK
55	Hammer	2005-2007	FA209/2	FA209/2V	FA209/2HH	EPFA209/2HH	MD678

* symbol after part# = 2 pieces required i.e. 2 pad sets or 2 rotors (twin rotor models)

Part numbers, prefixes, suffixes, photos and illustrations shown in this catalog are trademarks and/or copyrights of EBC Brakes or the trademark owner A C Freeman Investments Ltd and use without express written permission of the owners is punishable by law.

All names & numbers are for reference purposes only. © Registered trademarks of Harley—Davidson® Motor Corp or Buell.
 NOTE: — Some models may have a second rotor fitted as an optional extra. Please double check with your customer exactly which side the front rotor is fitted and if twin rotor or single.

FRONT: AMERICAN PRODUCED MOTORCYCLES



SUFFIX OR PREFIX
PAD MATERIALS AND DESCRIPTION

VICTORY

	YEAR	FRONT				FRONT ROTOR OPTIONS	Line #
		PADS	PADS	PADS	PADS	DESIGN NO.	
		FA	V	HH	EPFA		
		Organic Pads	Semi-Sintered V-Pads™	Double-H™ USA-Made Sintered Pads	Premium Low Noise Street Sintered Pads	See Buyers Guide for rotor style & finish options. Part nos for ordering & sizing.	
Vegas Jackpot	2006-2007	FA244	FA244V	FA244HH	EPFA244HH	MD678	1
Hammer S	2007	FA244*	FA244V*	FA244HH*	EPFA244HH*	MD678*	2
Jackpot	2007-2010			FA347HH	EPFA347HH	MD678	3
Hammer	2008-2011			FA347HH*	EPFA347HH*	MD890BLK*	4
Hammer S	2008-2017			FA347HH*	EPFA347HH*	MD890BLK*	5
Jackpot Cory Ness	2008-2010			FA347HH	EPFA347HH	MD678	6
King Pin	2008-2012			FA347HH	EPFA347HH	MD890BLK	7
King Pin 8-Ball	2008-2011			FA347HH	EPFA347HH	MD678	8
Vegas 8-Ball	2008-2010			FA347HH	EPFA347HH	MD678	9
Vegas Jackpot	2008-2012			FA347HH	EPFA347HH	MD678	10
Vegas Low	2008-2009			FA347HH	EPFA347HH	MD678	11
King Pin Low	2009			FA347HH	EPFA347HH	MD890BLK	12
Jackpot	2011-2016			FA347HH	EPFA347HH	MD890BLK	13
Vegas Jackpot	2013-2014			FA347HH	EPFA347HH	MD678	14
Vegas	2008-2012			FA347HH	EPFA347HH	MD678	15
Special Edition	2000	FA244	FA244V	FA244HH	EPFA244HH	MD727	16
Sport Cruiser	2000-2001	FA244*	FA244V*	FA244HH*	EPFA244HH*	MD727*	17
Ness Signature Series	2005-2007	FA244	FA244V	FA244HH	EPFA244HH	MD678	18
Vision Street	2008-2009			FA261HH*	EPFA261HH*	MD678	19
Vision Tour - All models	2008-2015			FA261HH*	EPFA261HH*	MD890BLK*	20
Cross Country	2010-2017			FA347HH*	EPFA347HH*	MD890BLK*	21
Cross Roads	2010-2012			FA347HH*	EPFA347HH*	MD890BLK*	22
Hammer 8-Ball	2010-2015			FA347HH	EPFA347HH	MD678	23
Vision 8-Ball	2010-2011			FA261HH*	EPFA261HH*	MD678	24
Vision Arlen Ness Victory Vision	2010-2012			FA261HH*	EPFA261HH*	MD890BLK*	25
Cross Country Cory Ness Victory	2011-2012			FA347HH*	EPFA347HH*	MD890BLK*	26
Vegas 8-Ball	2011-2017			FA347HH	EPFA347HH	MD678	27
Vegas Zach Ness	2011			FA347HH	EPFA347HH	MD678	28
Hard Ball	2012-2013			FA347HH*	EPFA347HH*	MD678*	29
High Ball	2012-2017			FA347HH	EPFA347HH	MD890BLK	30
Broadwalk	2013-2015			FA347HH	EPFA347HH	MD890BLK	31
Cross Country Touring	2013-2017			FA347HH*	EPFA347HH*	MD890BLK*	32
Cross Roads Classic	2013-2014			FA347HH*	EPFA347HH*	MD890BLK*	33
Judge	2013-2017			FA347HH	EPFA347HH	MD890BLK	34
Cross Roads 8-Ball	2014-2015			FA347HH*	EPFA347HH*	MD890BLK*	35
Cross Country 8-Ball	2015-2016			FA347HH*	EPFA347HH*	MD890BLK*	36
Gunner	2015-2017			FA347HH	EPFA347HH	MD890BLK	37
Magnum	2015-2017			FA347HH*	EPFA347HH*	MD890BLK	38
Magnum X-1	2015-2017			FA347HH*	EPFA347HH*	MD890BLK	39
Hammer 8-Ball	2016			FA347HH*	EPFA347HH*	MD890BLK*	40
Vegas	2016-2017			FA347HH	EPFA347HH	MD678	41

ZERO ELECTRIC

							42
							43
SRIF ZF 14.4 kWh	2019-2022	FA244*		FA244HH*	EPFA244HH*	MD8024X*	44
SRIS ZF 14.4 kWh	2019-2022	FA244*		FA244HH*	EPFA244HH	MD8024X*	45
FX ZF2.8 ZF5.7	2013-2014	FA185X		FA185R			46
S ZF8.5 ZF11.4	2013	FA185X		FA185R			47
S ZF8.5 ZF11.4	2014	FA185X		FA185R			48
DS II ZF9.4 ZF12.5	2015	FA209/2		FA209/2HH	EPFA209/2HH		49
FX ZF2.8 ZF5.7	2015	FA181X		FA181R			50
S ZF9.4 ZF12.5	2015	FA209/2		FA209/2HH	EPFA209/2HH		51
SR ZF12.5	2015	FA209/2		FA209/2HH	EPFA209/2HH		52
DS ZF13.0	2016-2019	FA209/2		FA209/2HH	EPFA209/2HH		53
FX ZF3.3 ZF6.5	2016-2022	FA209/2		FA209/2HH	EPFA209/2HH		54
S ZF9.8 ZF13.0	2016-2019	FA209/2		FA209/2HH	EPFA209/2HH		55

* symbol after part# = 2 pieces required i.e. 2 pad sets or 2 rotors (twin rotor models)

REAR: AMERICAN PRODUCED MOTORCYCLES



SUFFIX OR PREFIX
PAD MATERIALS AND DESCRIPTION

Line #	VICTORY	YEAR	REAR				REAR ROTOR OPTIONS
			PADS	PADS	PADS	PADS	DESIGN NO.
			FA	V	HH	EPFA	See Buyers Guide for rotor style & finish options. Part nos for ordering & sizing.
			Organic Pads	Semi-Sintered V-Pads™	Double-HTM USA-Made Sintered Pads	Premium Low Noise Street Sintered Pads	
1	Vegas Jackpot	2006-2007	FA209/2	FA209/2V	FA209/2HH	EPFA209/2HH	MD678
2	Hammer S	2007	FA209/2	FA209/2V	FA209/2HH	EPFA209/2HH	MD678
3	Jackpot	2007-2010	FA196	FA196V	FA196HH	EPFA196HH	MD678
4	Hammer	2008-2011	FA196	FA196V	FA196HH	EPFA196HH	MD890BLK
5	Hammer S	2008-2017	FA196	FA196V	FA196HH	EPFA196HH	MD890BLK
6	Jackpot Cory Ness	2008-2010	FA196	FA196V	FA196HH	EPFA196HH	MD890BLK
7	King Pin	2008-2012	FA196	FA196V	FA196HH	EPFA196HH	MD890BLK
8	King Pin 8-Ball	2008-2011	FA196	FA196V	FA196HH	EPFA196HH	MD890BLK
9	Vegas 8-Ball	2008-2010	FA196	FA196V	FA196HH	EPFA196HH	MD678
10	Vegas Jackpot	2008-2012	FA196	FA196V	FA196HH	EPFA196HH	MD678
11	Vegas Low	2008-2009	FA196	FA196V	FA196HH	EPFA196HH	MD678
12	King Pin Low	2009	FA196	FA196V	FA196HH	EPFA196HH	MD890BLK
13	Jackpot	2011-2016	FA196	FA196V	FA196HH	EPFA196HH	MD890BLK
14	Vegas Jackpot	2013-2014	FA196	FA196V	FA196HH	EPFA196HH	MD678
15	Vegas	2008-2012	FA196	FA196V	FA196HH	EPFA196HH	MD678
16	Special Edition	2000	FA209/2	FA209/2V	FA209/2HH	EPFA209/2HH	MD727
17	Sport Cruiser	2000-2001	FA209/2	FA209/2V	FA209/2HH	EPFA209/2HH	MD727
18	Ness Signature Series	2005-2007	FA209/2	FA209/2V	FA209/2HH	EPFA209/2HH	MD678
19	Vision Street	2008-2009	FA196	FA196V	FA196HH	EPFA196HH	MD887BLK
20	Vision Tour - All models	2008-2015	FA196	FA196V	FA196HH	EPFA196HH	MD887BLK
21	Cross Country	2010-2017	FA196	FA196V	FA196HH	EPFA196HH	MD887BLK
22	Cross Roads	2010-2012	FA196	FA196V	FA196HH	EPFA196HH	MD887BLK
23	Hammer 8-Ball	2010-2015	FA196	FA196V	FA196HH	EPFA196HH	MD890BLK
24	Vision 8-Ball	2010-2011	FA196	FA196V	FA196HH	EPFA196HH	MD887BLK
25	Vision Arlen Ness Victory Vision	2010-2012	FA196	FA196V	FA196HH	EPFA196HH	MD887BLK
26	Cross Country Cory Ness Victory	2011-2012	FA196	FA196V	FA196HH	EPFA196HH	MD887BLK
27	Vegas 8-Ball	2011-2017	FA196	FA196V	FA196HH	EPFA196HH	MD678
28	Vegas Zach Ness	2011	FA196	FA196V	FA196HH	EPFA196HH	MD678
29	Hard Ball	2012-2013	FA196	FA196V	FA196HH	EPFA196HH	MD887BLK
30	High Ball	2012-2017	FA196	FA196V	FA196HH	EPFA196HH	MD890BLK
31	Broadwalk	2013-2015	FA196	FA196V	FA196HH	EPFA196HH	MD887BLK
32	Cross Country Touring	2013-2017	FA196	FA196V	FA196HH	EPFA196HH	MD887BLK
33	Cross Roads Classic	2013-2014	FA196	FA196V	FA196HH	EPFA196HH	MD887BLK
34	Judge	2013-2017	FA196	FA196V	FA196HH	EPFA196HH	MD890BLK
35	Cross Roads 8-Ball	2014-2015	FA196	FA196V	FA196HH	EPFA196HH	MD887BLK
36	Cross Country 8-Ball	2015-2016	FA196	FA196V	FA196HH	EPFA196HH	MD887BLK
37	Gunner	2015-2017	FA196	FA196V	FA196HH	EPFA196HH	MD890BLK
38	Magnum	2015-2017	FA196	FA196V	FA196HH	EPFA196HH	MD887BLK
39	Magnum X-1	2015-2017	FA196	FA196V	FA196HH	EPFA196HH	MD887BLK
40	Hammer 8-Ball	2016	FA196	FA196V	FA196HH	EPFA196HH	MD890BLK
41	Vegas	2016-2017	FA196	FA196V	FA196HH	EPFA196HH	MD678
42							
43	ZERO ELECTRIC						
44	SRIF ZF 14.4 kWh	2019-2022	FA213		FA213HH	EPFA213HH	
45	SRIS ZF 14.4 kWh	2019-2022	FA213		FA213HH	EPFA213HH	
46	FX ZF2.8 ZF5.7	2013-2014	FA367X		FA367R		
47	S ZF8.5 ZF11.4	2013	FA367X		FA367R		
48	S ZF8.5 ZF11.4	2014	FA208X		FA208R		
49	DS II ZF9.4 ZF12.5	2015	FA213		FA213HH	EPFA213HH	
50	FX ZF2.8 ZF5.7	2015	FA208X		FA208R		
51	S ZF9.4 ZF12.5	2015	FA213		FA213HH	EPFA213HH	
52	SR ZF12.5	2015	FA213		FA213HH	EPFA213HH	
53	DS ZF13.0	2016-2019	FA213		FA213HH	EPFA213HH	
54	FX ZF3.3 ZF6.5	2016-2022	FA213		FA213HH	EPFA213HH	
55	S ZF9.8 ZF13.0	2016-2019	FA213		FA213HH	EPFA213HH	

* symbol after part# = 2 pieces required i.e. 2 pad sets or 2 rotors (twin rotor models)

Part numbers, prefixes, suffixes, photos and illustrations shown in this catalog are trademarks and/or copyrights of EBC Brakes or the trademark owner A C Freeman Investments Ltd and use without express written permission of the owners is punishable by law.

All names & numbers are for reference purposes only. © Registered trademarks of Harley—Davidson® Motor Corp or Buell.
 NOTE: — Some models may have a second rotor fitted as an optional extra. Please double check with your customer exactly which side the front rotor is fitted and if twin rotor or single.

FRONT: AMERICAN PRODUCED MOTORCYCLES



SUFFIX OR PREFIX
PAD MATERIALS AND DESCRIPTION

YEAR

ZERO ELECTRIC

		FRONT				FRONT ROTOR OPTIONS	
		PADS	PADS	PADS	PADS	DESIGN NO.	
		FA	V	HH	EPFA		
		Organic Pads	Semi-Sintered V-Pads™	Double-H™ USA-Made Sintered Pads	Premium Low Noise Street Sintered Pads	See Buyers Guide for rotor style & finish options. Part nos for ordering & sizing.	
SR ZF13.0	2016-2022	FA209/2		FA209/2HH	EPFA209/2HH		1
DSR ZF13.0	2017-2019	FA209/2		FA209/2HH	EPFA209/2HH		2
FXS ZF3.3 ZF6.5	2017-2022	FA209/2		FA209/2HH	EPFA209/2HH		3
DS II ZF14.4	2019-2021	FA209/2		FA209/2HH	EPFA209/2HH		4
DSR ZF14.4.0	2019-2022	FA209/2		FA209/2HH	EPFA209/2HH		5
DSR ZF7.2	2019-2022	FA209/2		FA209/2HH	EPFA209/2HH		6
FX Black Forest Edition - ZF14.4.0	2019-2021	FA209/2		FA209/2HH	EPFA209/2HH		7
S ZF14.4	2019-2021	FA209/2		FA209/2HH	EPFA209/2HH		8
S ZF7.2	2019-2022	FA209/2		FA209/2HH	EPFA209/2HH		9
DS II ZF14.4	2022-2024	FA244*		FA244HH*	EPFA244HH*	MD8024X*	10
DSR/X ZF75-10X 17.3.0 Adventure	2022-2024	FA244*		FA244HH*	EPFA244HH*	MD8024X*	11
FXE ZF7.2	2022-2024	FA209/2		FA209/2HH	EPFA209/2HH		12
S ZF14.4	2022-2024	FA244*		FA244HH*	EPFA244HH*	MD8024X*	13
DSR ZF15.6	2023-2024	FA244*		FA244HH*	EPFA244HH*	MD8024X*	14
FX ZF7.2	2023-2024	FA209/2		FA209/2HH	EPFA209/2HH		15
SR ZF15.6	2023-2024	FA244*		FA244HH*	EPFA244HH*	MD8024X*	16
SRIF ZF 17.3 kWh	2023-2024	FA244*		FA244HH*	EPFA244HH*	MD8024X*	17
SRIS ZF 17.3 kWh	2023-2024	FA244*		FA244HH*	EPFA244HH*	MD8024X*	18
SR F	2025-2026	FA244*		FA244HH*	EPFA244HH*	MD669X/XC*	19
S	2025-2026	FA244*		FA244HH*	EPFA244HH*	MD669X/XC*	20
DSR X	2025-2026	FA244		FA244HH	EPFA244HH	MD669X/XC	21
DS	2025-2026	FA244		FA244HH	EPFA244HH	MD669X/XC	22
							23
							24
							25
							26
							27
							28
							29
							30
							31
							32
							33
							34
							35
							36
							37
							38
							39
							40
							41
							42
							43
							44
							45
							46
							47
							48
							49
							50
							51
							52
							53
							54
							55

* symbol after part# = 2 pieces required i.e. 2 pad sets or 2 rotors (twin rotor models)

PADS FOR AFTERMARKET CALIPERS



BERINGER

SUFFIX OR PREFIX PAD MATERIALS AND DESCRIPTION	FA	V	HH	EPFA
	Organic Pads	Semi-Sintered V-Pads™	Double-H™/MXS USA-Made Sintered Pads	Premium Low Noise Street Sintered Pads
4 Piston Old Design	FA158		FA158HH	EPFA158HH
4 Piston Radial			MXS405	EPFA405HH
6 Piston New Design			MXS406	EPFA406HH
6 Piston Old Design	FA249		FA249HH	
6 Piston Old Design Endurance	FA249/2			
6 Piston Old design2 piston	FA47		FA47HH	

GMA

2 Piston rear large caliper model A CCI #09997	FA36	FA36V		
2 Piston small caliper model B CCI # 09996	FA76	FA76V		
4 Piston model F	FA115	FA115V	FA115HH	

IRON PEGASUS

Small caliper 2 Pin Fixing	FA115	FA115V	FA115HH	
Small caliper Single Pin Fixing	FA47		FA47HH	

JAYBRAKE

6 PFL 6 Piston for 11.5" disc Lower Height Friction			FA649HH	
Dual Quad 30004 2 & 4 Piston	FA115	FA115V	FA115HH	
Early Design 2 Piston	FA76	FA76V		
JFour 30044 4 Piston	FA188		FA188HH	EPFA188HH
JSix 30064 6 Piston	FA243		FA243HH	

PERFORMANCE MACHINE

112 X 6B	FA249		FA249HH	
112 X 6QC	FA249		FA249HH	
112 X 6RSB	FA190	FA190V	FA190HH	EPFA190HH
112 X 6SSB	FA190	FA190V	FA190HH	EPFA190HH
124 X 4HR	FA216/2			
125 X 2	FA115	FA115V	FA115HH	
125 X 4R	FA216/3	FA216/3V	FA216/3HH	
125 X 4RSPH	FA216/3	FA216/3V	FA216/3HH	
125 X 4S	FA115	FA115V	FA115HH	
125 X 4SL	FA115	FA115V	FA115HH	
125 X 6	FA210			
125 X 6QC	FA190	FA190V	FA190HH	
137 X 4	FA216/2			
137 X 4 2006			FA420HH	
137 X 4B	FA216/3	FA216/3V	FA216/3HH	
137 X 6	FA210			
162 X 2	FA32	FA32V		

REVTECH

CCI Polished Caliper FrontRear	FA95	FA95V	FA95HH	EPFA95HH
New Black 4 Piston Caliper	FA216/3	FA216/3V	FA216/3HH	

WILWOOD

GP300310 Part # 15087332	FA95	FA95V	FA95HH	EPFA95HH
GP320 Part # 1548596K	FA95	FA95V	FA95HH	EPFA95HH
PS1 Caliper Part # 1504091K	FA271X		FA271R	

* symbol after part# = 2 pieces required i.e. 2 pad sets or 2 rotors (twin rotor models)

EBC BRAKE PAD BUYERS GUIDE

FA24/2 113.5 x 64.5 x 7mm



BANANA CALIPER

MATERIAL AVAILABILITY					
FA	X	V	R	HH	EPFA
●		●			

FA26 75.5 x 50 x 7mm



Complete with four rivets

MATERIAL AVAILABILITY					
FA	X	V	R	HH	EPFA
●					

FA36 58 x 54 x 9mm



MATERIAL AVAILABILITY					
FA	X	V	R	HH	EPFA
●		●			

FA47 40 x 50.5 x 7mm



MATERIAL AVAILABILITY					
FA	X	V	R	HH	EPFA
●	●	●		●	

FA71 53.5 x 68.5 x 6.5mm



MATERIAL AVAILABILITY					
FA	X	V	R	HH	EPFA
●		●			

FA72 71 x 89 x 6.5mm



MATERIAL AVAILABILITY					
FA	X	V	R	HH	EPFA
●		●			

FA76 48.5 x 58 x 7mm



MATERIAL AVAILABILITY					
FA	X	V	R	HH	EPFA
●		●		●	

FA78 74.5 x 49 x 12mm



GIRLING CALIPER

MATERIAL AVAILABILITY					
FA	X	V	R	HH	EPFA
●		●		●	

FA79 174.5 x 72.5 x 10mm



MATERIAL AVAILABILITY					
FA	X	V	R	HH	EPFA
●		●			

FA83 A. 47.5 x 37 x 9mm

B. 85.5 x 42.5 x 7mm



MATERIAL AVAILABILITY					
FA	X	V	R	HH	EPFA
	●			●	●

FA86 77 x 42 x 7.5mm



MATERIAL AVAILABILITY					
FA	X	V	R	HH	EPFA
●				●	

FA94 56 x 60 x 13mm



HAYES CALIPER

MATERIAL AVAILABILITY					
FA	X	V	R	HH	EPFA
●		●		●	●

FA95 69.5 x 51 x 8mm



MATERIAL AVAILABILITY					
FA	X	V	R	HH	EPFA
●		●		●	●

FA115 36 x 45 x 6mm



MATERIAL AVAILABILITY					
FA	X	V	R	HH	EPFA
●		●		●	

EBC BRAKE PAD BUYERS GUIDE

FA135 A 97 x 42 x 7.5mm
B 77 x 42 x 7.5mm



MATERIAL AVAILABILITY					
FA	X	V	R	HH	EPFA
	●		●		

FA140 86.5 x 39.5 x 10mm



MATERIAL AVAILABILITY					
FA	X	V	R	HH	EPFA
●		●		●	

FA158 70 x 46.5 x 8mm



MATERIAL AVAILABILITY					
FA	X	V	R	HH	EPFA
●				●	●

FA165 A 97 x 42 x 7.5mm
B 77 x 42 x 7.5mm



MATERIAL AVAILABILITY					
FA	X	V	R	HH	EPFA
	●		●		

FA175 33.5 x 51 x 7mm



MATERIAL AVAILABILITY					
FA	X	V	R	HH	EPFA
●				●	

FA181 94 x 36.5 x 7.5mm



MATERIAL AVAILABILITY					
FA	X	V	R	HH	EPFA
	●	●	●	●	●

FA185 94 x 33.5 x 7mm



MATERIAL AVAILABILITY					
FA	X	V	R	HH	EPFA
	●		●		●

FA188 89.5 x 53 x 9mm (inc fitted shim)



MATERIAL AVAILABILITY					
FA	X	V	R	HH	EPFA
●				●	●

FA190 99 x 49.5 x 10mm



MATERIAL AVAILABILITY					
FA	X	V	R	HH	EPFA
●		●		●	●

FA196 102 x 39 x 10mm



MATERIAL AVAILABILITY					
FA	X	V	R	HH	EPFA
●		●		●	●

FA200 103 x 62 x 11.5mm



INCLUDES STEEL SLIDER SHIMS.
PLEASE REFER TO TECH PAGES
AT THE FRONT OF HANDBOOK

MATERIAL AVAILABILITY					
FA	X	V	R	HH	EPFA
●		●		●	●

FA201 103 x 62 x 11.5mm



INCLUDES STEEL SLIDER SHIMS.
PLEASE REFER TO TECH PAGES
AT THE FRONT OF HANDBOOK

MATERIAL AVAILABILITY					
FA	X	V	R	HH	EPFA
●		●		●	●

FA208 78 x 41 x 9mm



MATERIAL AVAILABILITY					
FA	X	V	R	HH	EPFA
	●		●		

FA209/2 108.5 x 40.5 x 7.5mm



MATERIAL AVAILABILITY					
FA	X	V	R	HH	EPFA
●		●		●	●

EBC BRAKE PAD BUYERS GUIDE

FA210 112 x 56.5 x 10mm



MATERIAL AVAILABILITY					
FA	X	V	R	HH	EPFA
●					

FA213 78 x 41.5 x 9mm



MATERIAL AVAILABILITY					
FA	X	V	R	HH	EPFA
●		●		●	●

FA216/2 69 x 50.5 x 10.5mm



MATERIAL AVAILABILITY					
FA	X	V	R	HH	EPFA
●				●	

FA216/3 69 x 50.5 x 8mm



MATERIAL AVAILABILITY					
FA	X	V	R	HH	EPFA
●		●		●	

FA243 98.5 x 49.5 x 8.5mm



MATERIAL AVAILABILITY					
FA	X	V	R	HH	EPFA
●				●	

FA244 75 x 55 x 8.5mm



MATERIAL AVAILABILITY					
FA	X	V	R	HH	EPFA
●		●		●	●

FA249 91.5 x 51.5 x 10mm



MATERIAL AVAILABILITY					
FA	X	V	R	HH	EPFA
●				●	●

FA251 A. 85 x 42.5 x 8mm
B. 55.5 x 37 x 10mm



MATERIAL AVAILABILITY					
FA	X	V	R	HH	EPFA
●					

FA254 60 x 57 x 8mm



MATERIAL AVAILABILITY					
FA	X	V	R	HH	EPFA
●		●		●	●

FA261 116 x 40.5 x 8.5mm



MATERIAL AVAILABILITY					
FA	X	V	R	HH	EPFA
		●		●	●

FA264 A. 84.5 x 43.5 x 8mm
B. 70 x 41 x 8mm



MATERIAL AVAILABILITY					
FA	X	V	R	HH	EPFA
●				●	

FA266 51.5 x 54.5 x 7.5mm



MATERIAL AVAILABILITY					
FA	X	V	R	HH	EPFA
●		●		●	●

FA296 75 x 55 x 7.5mm



MATERIAL AVAILABILITY					
FA	X	V	R	HH	EPFA
				●	●

FA317 A. 82 x 41 x 9.5mm
B. 62 x 41 x 9.5mm



MATERIAL AVAILABILITY					
FA	X	V	R	HH	EPFA
	●			●	

EBC BRAKE PAD BUYERS GUIDE

FA345 91.5 x 49.5 x 8mm



6 piston caliper can refit original backing shim if desired

MATERIAL AVAILABILITY					
FA	X	V	R	HH	EPFA
				●	●

FA347 69.5 x 49.5 x 7mm



MATERIAL AVAILABILITY					
FA	X	V	R	HH	EPFA
				●	●

FA367 67 x 36 x 11mm



MATERIAL AVAILABILITY					
FA	X	V	R	HH	EPFA
	●		●		●

FA377 A 94 x 47 x 8.5mm
B 73 x 47 x 11mm

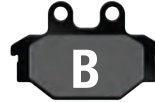

MATERIAL AVAILABILITY					
FA	X	V	R	HH	EPFA
●		●		●	

FA381 102 x 45.5 x 11mm



MATERIAL AVAILABILITY					
FA	X	V	R	HH	EPFA
●		●		●	●

FA387 86.5 x 44.5 x 10.5mm



MATERIAL AVAILABILITY					
FA	X	V	R	HH	EPFA
●		●		●	●

FA400 98 x 64 x 8mm
HH = 7.5mm thickness



MATERIAL AVAILABILITY					
FA	X	V	R	HH	EPFA
●		●		●	●

FA409 92 x 58.5 x HH/EPFA = 7mm
92 x 58.5 x FA/FA-V = 8mm



MATERIAL AVAILABILITY					
FA	X	V	R	HH	EPFA
●		●		●	●

FA420 69.5 x 54.5 x 8mm



MATERIAL AVAILABILITY					
FA	X	V	R	HH	EPFA
				●	

FA424 91.5 x 51.5 x 8mm



MATERIAL AVAILABILITY					
FA	X	V	R	HH	EPFA
●				●	●

FA434 A/B 98 x 64 x 8mm

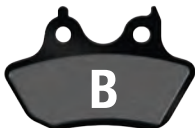

NOTE: Will not interchange with FA299 or FA400.
Check old pad shape against drawing to ensure correct pad selected.

MATERIAL AVAILABILITY					
FA	X	V	R	HH	EPFA
●		●		●	

FA435/4 43.5 x 49 x 9.5mm



MATERIAL AVAILABILITY					
FA	X	V	R	HH	EPFA
				●	●

FA447 102 x 42 x 7.5mm



MATERIAL AVAILABILITY					
FA	X	V	R	HH	EPFA
				●	●

FA454/4 61.5 x 46.5 x 7.5mm (inc shims)



MATERIAL AVAILABILITY					
FA	X	V	R	HH	EPFA
				●	●

EBC BRAKE PAD BUYERS GUIDE

FA455 99 x 54.5 x 9mm



MATERIAL AVAILABILITY					
FA	X	V	R	HH	EPFA
				●	

FA457 90.5 x 62 x 8mm



MATERIAL AVAILABILITY					
FA	X	V	R	HH	EPFA
		●		●	●

FA458 127.5 x 52.5 x HH/EPFA = 7.5mm
127.5 x 52.5 x FA-V = 8mm



MATERIAL AVAILABILITY					
FA	X	V	R	HH	EPFA
●		●		●	●

FA460 46.5 x 49.5 x 7mm



MATERIAL AVAILABILITY					
FA	X	V	R	HH	EPFA
				●	

FA473 110.5 x 53.5 x 8mm



MATERIAL AVAILABILITY					
FA	X	V	R	HH	EPFA
●		●			

FA474 75.5 x 33 x 8mm



MATERIAL AVAILABILITY					
FA	X	V	R	HH	EPFA
●		●			

FA605/4 97.5 x 46.5 x 7mm Hardware included



MATERIAL AVAILABILITY					
FA	X	V	R	HH	EPFA
		●		●	

FA630 85 x 50.5 x 8mm



MATERIAL AVAILABILITY					
FA	X	V	R	HH	EPFA
		●		●	●

FA631 96.5 x 43.5 x 8mm



MATERIAL AVAILABILITY					
FA	X	V	R	HH	EPFA
		●		●	

FA638 173.5 x 48.5 x HH/EPFA = 7mm
FA/FA-V = 8mm



MATERIAL AVAILABILITY					
FA	X	V	R	HH	EPFA
●		●		●	●

FA640 118 x 48.5 x 9.5mm



MATERIAL AVAILABILITY					
FA	X	V	R	HH	EPFA
●		●		●	●

FA641/4 88 x 43 x 8mm



MATERIAL AVAILABILITY					
FA	X	V	R	HH	EPFA
		●		●	

FA643 94 x 36.5 x 9mm



MATERIAL AVAILABILITY					
FA	X	V	R	HH	EPFA
		●		●	

FA649 99 x 55 x 8.5mm



MATERIAL AVAILABILITY					
FA	X	V	R	HH	EPFA
				●	

EBC BRAKE PAD BUYERS GUIDE

FA669/4 137.5 x 49.5 x 15mm
(4 pad set)



MATERIAL AVAILABILITY					
FA	X	V	R	HH	EPFA
●					

FA670 137.5 x 49.5 x 6mm
(2 pad set)



MATERIAL AVAILABILITY					
FA	X	V	R	HH	EPFA
●					

FA672 114.5 x 38.5 x 9.5mm



MATERIAL AVAILABILITY					
FA	X	V	R	HH	EPFA
●		●		●	●

FA696 55 x 53.5 x 9mm



MATERIAL AVAILABILITY					
FA	X	V	R	HH	EPFA
●		●		●	●

FA710 82 x 42 x 10mm



MATERIAL AVAILABILITY					
FA	X	V	R	HH	EPFA
		●		●	

FA760 83 x 49 x 8mm



MATERIAL AVAILABILITY					
FA	X	V	R	HH	EPFA
●		●		●	●

KEY GUIDE

Please see guide below for actual friction material and plate colour.

Sport. Organic (FA) ●



Touring. Semi-Sintered (V) ●



Streetbikes. Sintered (HH) ●



Premium ultra silent sintered grade (EPFA) ●



ROTOR GROUP NO. 001 - FRONT. CHOOSE YOUR PREFERRED STYLE:

Type	Solid	OD	11.5" / 290mm
Color /Finish	Natural	Thickness	0.196" / 5mm
Bobbins	None	Bore	2.22" / 56.4mm
F/R	Front	Bolt Holes	Counterbored



FSD008
Fits EBC Pads: 94, 381, 400, 457

Type	Floating	OD	11.5" / 290mm
Color /Finish	Polished	Thickness	0.196" / 5mm
Bobbins	5	Bore	2.22" / 56.4mm
F/R	Front	Bolt Holes	Counterbored

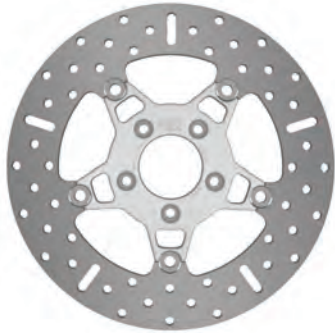

FSD010
Fits EBC Pads: 94, 381, 400, 457

Type	Floating	OD	11.5" / 290mm
Color /Finish	Black	Thickness	0.196" / 5mm
Bobbins	5	Bore	2.22" / 56.4mm
F/R	Front	Bolt Holes	Counterbored



FSD010BLK
Fits EBC Pads: 94, 381, 400, 457

Type	Floating	OD	11.5" / 290mm
Color /Finish	Polished	Thickness	0.196" / 5mm
Bobbins	5	Bore	2.22" / 56.4mm
F/R	Front	Bolt Holes	Counterbored

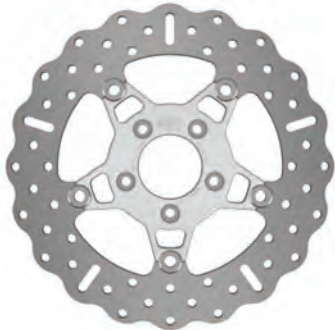

FSD012C
Fits EBC Pads: 94, 381, 400, 457

Type	Floating	OD	11.5" / 290mm
Color /Finish	Black	Thickness	0.196" / 5mm
Bobbins	5	Bore	2.22" / 56.4mm
F/R	Front	Bolt Holes	Counterbored



FSD012CBLK
Fits EBC Pads: 94, 381, 400, 457

Type	Floating	OD	11.5" / 290mm
Color /Finish	Black	Thickness	0.196" / 5mm
Bobbins	5	Bore	2.22" / 56.4mm
F/R	Front	Bolt Holes	Counterbored



VR010BLK
Fits EBC Pads: 94, 381, 400, 457

Type	Floating	OD	11.5" / 290mm
Color /Finish	Black	Thickness	0.196" / 5mm
Bobbins	10	Bore	2.22" / 56.4mm
F/R	Front	Bolt Holes	Counterbored

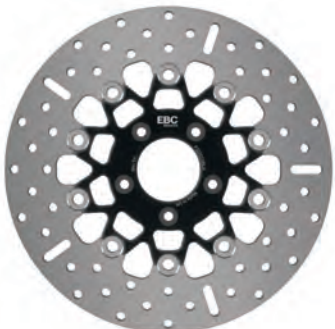

FSD023BLK
Fits EBC Pads: 94, 381, 400, 457

Type	Floating	OD	11.5" / 290mm
Color /Finish	Polished	Thickness	0.196" / 5mm
Bobbins	10	Bore	2.22" / 56.4mm
F/R	Front	Bolt Holes	Counterbored

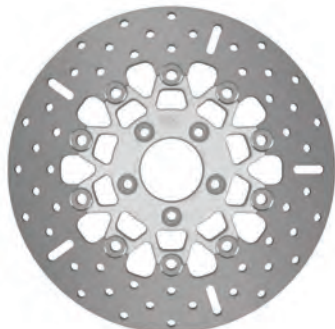

FSD023
Fits EBC Pads: 94, 381, 400, 457

Type	Floating	OD	11.5" / 290mm
Color /Finish	Black	Thickness	0.196" / 5mm
Bobbins	10	Bore	2.22" / 56.4mm
F/R	Front	Bolt Holes	Counterbored



FSD027CBLK
Fits EBC Pads: 94, 381, 400, 457

Type	Floating	OD	11.5" / 290mm
Color /Finish	Polished	Thickness	0.196" / 5mm
Bobbins	10	Bore	2.22" / 56.4mm
F/R	Front	Bolt Holes	Counterbored

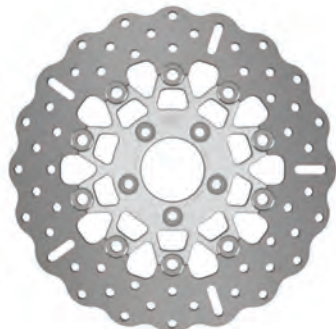

FSD027C
Fits EBC Pads: 94, 381, 400, 457

ROTOR GROUP NO. 001 - FRONT. CHOOSE YOUR PREFERRED STYLE:

Type	Floating	OD	11.5" / 290mm
Color /Finish	Black	Thickness	0.196" / 5mm
Bobbins	10	Bore	2.22" / 56.4mm
F/R	Front	Bolt Holes	Counterbored



VR023BLK
Fits EBC Pads: 94, 381, 400, 457

Type	Floating	OD	14" / 355mm
Color /Finish	Black	Thickness	0.196" / 5mm
Bobbins	5	Bore	2.22" / 56.4mm
F/R	Front	Bolt Holes	Counterbored

OVERSIZE ROTOR OPTION



OSMD004-14BLK
Fits EBC Pads: 94, 381, 400, 457



Relocation bracket & hardware available to purchase separately
BRK707 **BRK708**

Type	Floating	OD	15" / 381mm
Color /Finish	Black	Thickness	0.196" / 5mm
Bobbins	5	Bore	2.22" / 56.4mm
F/R	Front	Bolt Holes	Counterbored

OVERSIZE ROTOR OPTION

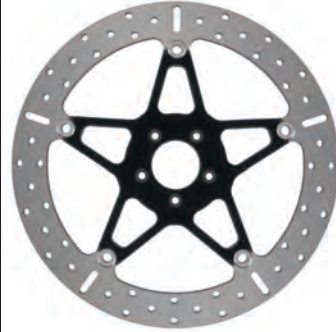

OSMD004-15BLK
Fits EBC Pads: 94, 381, 400, 457



Relocation bracket & hardware available to purchase separately
BRK709 **BRK710**

Increased stopping power, feel and control with the EBC FULLY floating oversize range. These kits bolt directly onto your bike using the stock caliper and also deliver the advantages of a floating rotor over solid designs.

5 button or 10 button Floating Rotors

Light duty 5 button rotors are designed for bikes with a TWIN front rotor set up.
Heavy duty 10 button rotors are designed for bikes with a SINGLE front rotor set up.

ROTOR BOLT KITS

All manufacturers recommend new rotor bolts when replacing brake rotors on any motorcycle. EBC Brakes have rotor bolt kits specifically for Harley Davidson.

Our rotor bolt kits are manufactured from stainless steel with thread lock applied and comply with original manufacturers specifications, supplied in sets of 5.

ROTOR BOLT KITS AVAILABLE

HBK001	5 bolts in chrome finish 5/16 UNC - Front
HBK002	5 bolts in Black Chrome finish 5/16 UNC - Front
HBK003	5 bolts in chrome finish 3/8 UNC - Rear
HBK004	5 bolts in Black Chrome finish 3/8 UNC - Rear



ROTOR GROUP NO. 002 - FRONT. CHOOSE YOUR PREFERRED STYLE:

Type	Solid	OD	11.5" / 290mm
Color /Finish	Natural	Thickness	0.196" / 5mm
Bobbins	None	Bore	1.99" / 50.6mm
F/R	Front	Bolt Holes	Counterbored



FSD007
Fits EBC Pads: 94, 216/3

Type	Floating	OD	11.5" / 290mm
Color /Finish	Polished	Thickness	0.196" / 5mm
Bobbins	5	Bore	1.99" / 50.6mm
F/R	Front	Bolt Holes	Counterbored

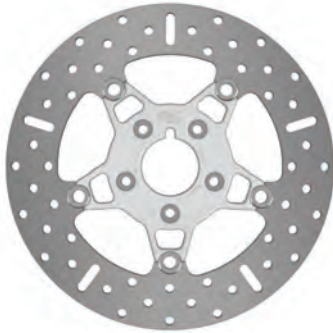

FSD009
Fits EBC Pads: 94, 216/3

Type	Floating	OD	11.5" / 290mm
Color /Finish	Black	Thickness	0.196" / 5mm
Bobbins	5	Bore	1.99" / 50.6mm
F/R	Front	Bolt Holes	Counterbored



FSD009BLK
Fits EBC Pads: 94, 216/3

Type	Floating	OD	11.5" / 290mm
Color /Finish	Polished	Thickness	0.196" / 5mm
Bobbins	5	Bore	1.99" / 50.6mm
F/R	Front	Bolt Holes	Counterbored

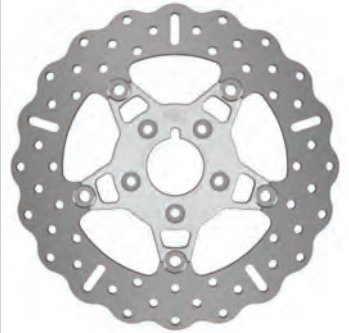

FSD011C
Fits EBC Pads: 94, 216/3

Type	Floating	OD	11.5" / 290mm
Color /Finish	Black	Thickness	0.196" / 5mm
Bobbins	5	Bore	1.99" / 50.6mm
F/R	Front	Bolt Holes	Counterbored



FSD011CBLK
Fits EBC Pads: 94, 216/3

Type	Floating	OD	11.5" / 290mm
Color /Finish	Polished	Thickness	0.196" / 5mm
Bobbins	10	Bore	1.99" / 50.6mm
F/R	Front	Bolt Holes	Counterbored

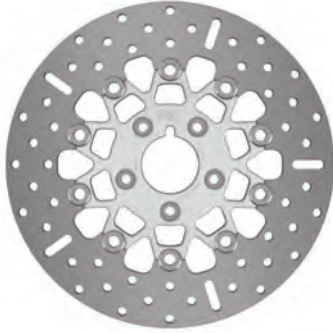

FSD022
Fits EBC Pads: 94, 216/3

Type	Floating	OD	11.5" / 290mm
Color /Finish	Black	Thickness	0.196" / 5mm
Bobbins	10	Bore	1.99" / 50.6mm
F/R	Front	Bolt Holes	Counterbored

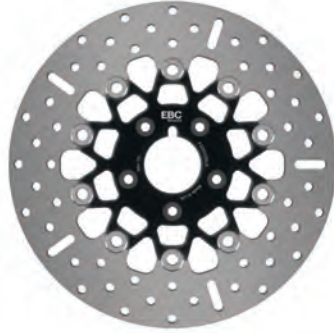

FSD022BLK
Fits EBC Pads: 94, 216/3

Type	Floating	OD	11.5" / 290mm
Color /Finish	Polished	Thickness	0.196" / 5mm
Bobbins	10	Bore	1.99" / 50.6mm
F/R	Front	Bolt Holes	Counterbored

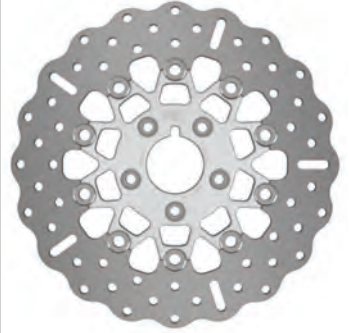

FSD026C
Fits EBC Pads: 94, 216/3

Type	Floating	OD	11.5" / 290mm
Color /Finish	Black	Thickness	0.196" / 5mm
Bobbins	10	Bore	1.99" / 50.6mm
F/R	Front	Bolt Holes	Counterbored

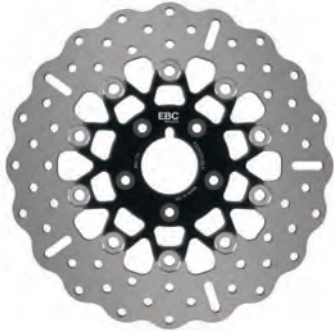

FSD026CBLK
Fits EBC Pads: 94, 216/3

Type	Floating	OD	11.5" / 290mm
Color /Finish	Black	Thickness	0.196" / 5mm
Bobbins	5	Bore	1.99" / 50.6mm
F/R	Front	Bolt Holes	Counterbored



VR011BLK
Fits EBC Pads: 94, 216/3

5 button or 10 button Floating Rotors

Light duty 5 button rotors are designed for bikes with a TWIN front rotor set up.

Heavy duty 10 button rotors are designed for bikes with a SINGLE front rotor set up.

ROTOR GROUP NO. 003 - REAR. CHOOSE YOUR PREFERRED STYLE:

Type	Floating	OD	11.5" / 290mm
Color /Finish	Polished	Thickness	0.236" / 6mm
Bobbins	10	Bore	2.22" / 56.4mm
F/R	Rear	Bolt Holes	Counterbored

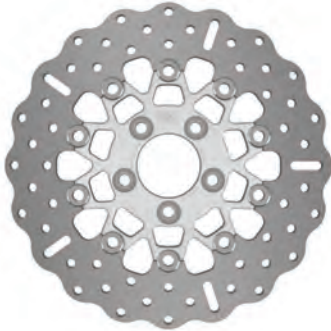

RSD018C
Fits EBC Pads: 387, 400, 434, 458, 710

Type	Floating	OD	11.5" / 290mm
Color /Finish	Polished	Thickness	0.236" / 6mm
Bobbins	10	Bore	2.22" / 56.4mm
F/R	Rear	Bolt Holes	Counterbored

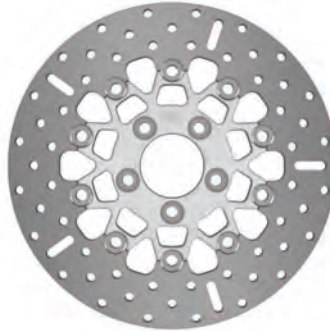

RSD020
Fits EBC Pads: 387, 400, 434, 458, 710

Type	Solid	OD	11.5" / 290mm
Color /Finish	Natural	Thickness	0.236" / 6mm
Bobbins	None	Bore	2.22" / 56.4mm
F/R	Rear	Bolt Holes	Counterbored



RSD008
Fits EBC Pads: 387, 400, 434, 458, 710

Type	Floating	OD	11.5" / 290mm
Color /Finish	Black	Thickness	0.236" / 6mm
Bobbins	10	Bore	2.22" / 56.4mm
F/R	Rear	Bolt Holes	Counterbored



RSD018CBLK
Fits EBC Pads: 387, 400, 434, 458, 710

Type	Floating	OD	11.5" / 290mm
Color /Finish	Black	Thickness	0.236" / 6mm
Bobbins	10	Bore	2.22" / 56.4mm
F/R	Rear	Bolt Holes	Counterbored

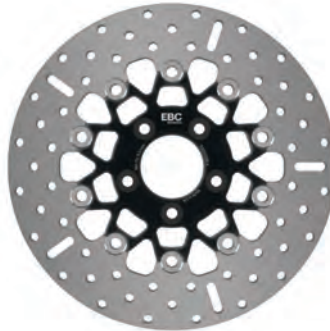

RSD020BLK
Fits EBC Pads: 387, 400, 434, 458, 710

Type	Floating	OD	11.5" / 290mm
Color /Finish	Black	Thickness	0.236" / 6mm
Bobbins	10	Bore	2.22" / 56.4mm
F/R	Rear	Bolt Holes	Counterbored



VR020BLK
Fits EBC Pads: 387, 400, 434, 458, 710

ROTOR BOLT KITS AVAILABLE	
HBK001	5 bolts in chrome finish 5/16 UNC - Front
HBK002	5 bolts in Black Chrome finish 5/16 UNC - Front
HBK003	5 bolts in chrome finish 3/8 UNC - Rear
HBK004	5 bolts in Black Chrome finish 3/8 UNC - Rear



ROTOR GROUP NO. 004 - REAR. CHOOSE YOUR PREFERRED STYLE:

Type	Solid	OD	11.5" / 290mm
Color /Finish	Natural	Thickness	0.236" / 6mm
Bobbins	None	Bore	1.99" / 50.6mm
F/R	Rear	Bolt Holes	Counterbored

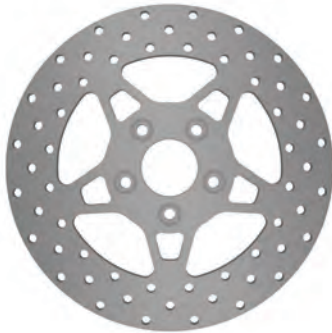

RSD007

Fits EBC Pads: 200, 216/3

Type	Floating	OD	11.5" / 290mm
Color /Finish	Polished	Thickness	0.236" / 6mm
Bobbins	10	Bore	1.99" / 50.6mm
F/R	Rear	Bolt Holes	Counterbored

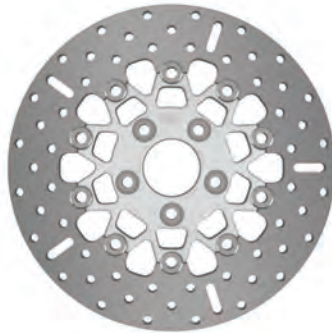

RSD019

Fits EBC Pads: 200, 216/3

Type	Floating	OD	11.5" / 290mm
Color /Finish	Black	Thickness	0.236" / 6mm
Bobbins	10	Bore	1.99" / 50.6mm
F/R	Rear	Bolt Holes	Counterbored

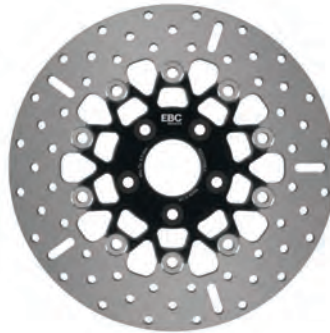

RSD019BLK

Fits EBC Pads: 200, 216/3

Type	Floating	OD	11.5" / 290mm
Color /Finish	Black	Thickness	0.236" / 6mm
Bobbins	10	Bore	1.99" / 50.6mm
F/R	Rear	Bolt Holes	Counterbored



RSD017CBLK

Fits EBC Pads: 200, 216/3

Type	Floating	OD	11.5" / 290mm
Color /Finish	Polished	Thickness	0.236" / 6mm
Bobbins	10	Bore	1.99" / 50.6mm
F/R	Rear	Bolt Holes	Counterbored

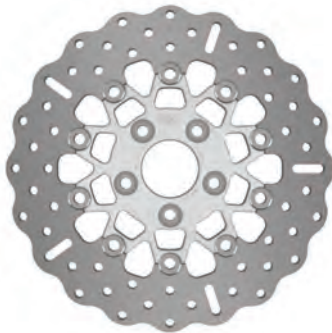

RSD019C

Fits EBC Pads: 200, 216/3

Type	Floating	OD	11.5" / 290mm
Color /Finish	Black	Thickness	0.236" / 6mm
Bobbins	10	Bore	1.99" / 50.6mm
F/R	Rear	Bolt Holes	Counterbored



VR019BLK

Fits EBC Pads: 200, 216/3

MD509SR

Type	Solid	OD	11.5" / 290mm
Color /Finish	Natural	Thickness	0.314" / 8mm
Bobbins	None	Bore	4" / 101.8mm
F/R	Rear	Bolt Holes	Plain



MD509SR – Billet Steel

Fits EBC Pads: 201, 201V only

MD511

Type	Solid	OD	9.44" / 240mm
Color /Finish	Natural	Thickness	0.196" / 5mm
Bobbins	None	Bore	4.13" / 105mm
F/R	Rear	Bolt Holes	Countersunk



MD511
Fits EBC Pads: 140, 251

ROTOR BOLT KITS AVAILABLE

HBK001	5 bolts in chrome finish 5/16 UNC - Front
HBK002	5 bolts in Black Chrome finish 5/16 UNC - Front
HBK003	5 bolts in chrome finish 3/8 UNC - Rear
HBK004	5 bolts in Black Chrome finish 3/8 UNC - Rear



ROTOR GROUP NO. 006 – FRONT/REAR. CHOOSE YOUR PREFERRED STYLE:

Type	Solid	OD	11.5" / 290mm
Color /Finish	Natural	Thickness	0.196" / 5mm
Bobbins	None	Bore	6.77" / 172mm
F/R	F/R	Bolt Holes	N/A



MD514LS
Fits EBC Pads: 400

Type	Solid	OD	11.5" / 290mm
Color /Finish	Natural	Thickness	0.196" / 5mm
Bobbins	None	Bore	6.77" / 172mm
F/R	F/R	Bolt Holes	N/A

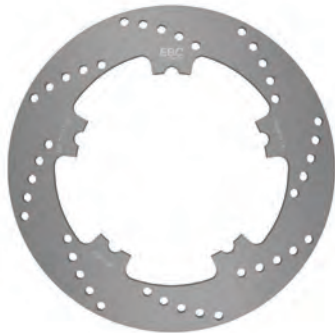

MD514RS
Fits EBC Pads: 400

Type	Solid	OD	11.5" / 290mm
Color /Finish	Natural	Thickness	0.196" / 5mm
Bobbins	None	Bore	6.77" / 172mm
F/R	F/R	Bolt Holes	N/A



VR514
Fits EBC Pads: 400

MD515

Type	Solid	OD	11.5" / 290mm
Color /Finish	Natural	Thickness	0.236" / 6mm
Bobbins	None	Bore	4" / 101.4mm
F/R	Rear	Bolt Holes	Counterbored



MD515
Fits EBC Pads: 400

ROTOR GROUP NO. 007 - FRONT. CHOOSE YOUR PREFERRED STYLE:

Type	Solid	OD	11.8" / 300mm
Color /Finish	Natural	Thickness	0.196" / 5mm
Bobbins	None	Bore	6.7" / 171mm
F/R	Front	Bolt Holes	N/A

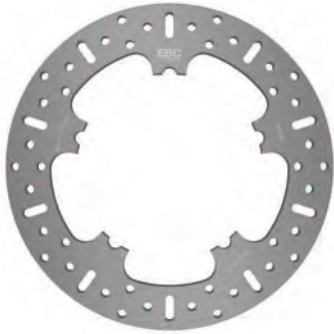

MD516
Fits EBC Pads: 400, 409, 457

Type	Floating	OD	11.8" / 300mm
Color /Finish	Polished	Thickness	0.196" / 5mm
Bobbins	5	Bore	6.7" / 171mm
F/R	Front	Bolt Holes	N/A

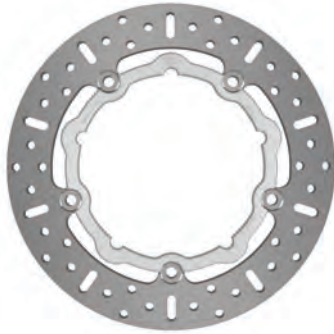

MD516X
Fits EBC Pads: 400, 409, 457

Type	Floating	OD	14" / 355mm
Color /Finish	Black	Thickness	0.196" / 5mm
Bobbins	5	Bore	6.7" / 171mm
F/R	Front	Bolt Holes	N/A

OVERSIZE ROTOR OPTION



OSMD516-14BLK
Fits EBC Pads: 400, 409, 457



Relocation bracket & hardware available to purchase separately

BRK703

BRK704

Type	Floating	OD	15" / 381mm
Color /Finish	Black	Thickness	0.196" / 5mm
Bobbins	5	Bore	6.7" / 171mm
F/R	Front	Bolt Holes	N/A

OVERSIZE ROTOR OPTION



OSMD516-15BLK
Fits EBC Pads: 400, 409, 457



Relocation bracket & hardware available to purchase separately

BRK707

BRK708

Increased stopping power, feel and control with the EBC FULLY floating oversize range. These kits bolt directly onto your bike using the stock caliper and also deliver the advantages of a floating rotor over solid designs.

ROTOR GROUP NO. 008 - REAR. CHOOSE YOUR PREFERRED STYLE:

Type	Solid	OD	11.8" / 300mm
Color /Finish	Natural	Thickness	0.275" / 7mm
Bobbins	None	Bore	4" / 101.6mm
F/R	Rear	Bolt Holes	Counterbored



MD517
Fits EBC Pads: 409

Type	Floating	OD	11.8" / 300mm
Color /Finish	Polished	Thickness	0.275" / 7mm
Bobbins	9	Bore	4" / 101.6mm
F/R	Rear	Bolt Holes	Counterbored

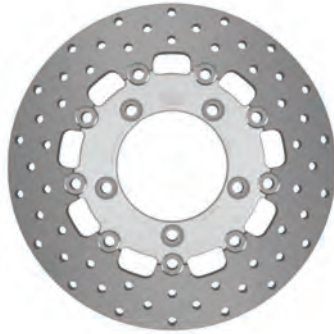

MD525
Fits EBC Pads: 409

ROTOR GROUP NO. 009 – REAR. CHOOSE YOUR PREFERRED STYLE:

Type	Solid	OD	11.8" / 300mm
Color /Finish	Natural	Thickness	0.275" / 7mm
Bobbins	None	Bore	2.22" / 56.4mm
F/R	Rear	Bolt Holes	Counterbored



MD542
Fits EBC Pads: 409

Type	Floating	OD	11.8" / 300mm
Color /Finish	Polished	Thickness	0.275" / 7mm
Bobbins	10	Bore	2.22" / 56.4mm
F/R	Rear	Bolt Holes	Counterbored

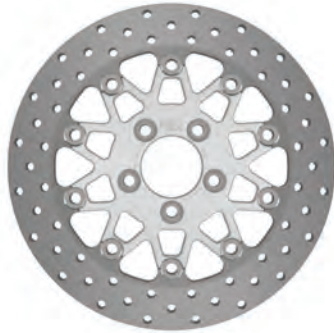

MD521
Fits EBC Pads: 409

Type	Floating	OD	11.8" / 300mm
Color /Finish	Black	Thickness	0.275" / 7mm
Bobbins	10	Bore	2.22" / 56.4mm
F/R	Rear	Bolt Holes	Counterbored



MD521BLK
Fits EBC Pads: 409

Type	Floating	OD	11.8" / 300mm
Color /Finish	Black	Thickness	0.275" / 7mm
Bobbins	10	Bore	2.22" / 56.4mm
F/R	Rear	Bolt Holes	Counterbored



VR521BLK
Fits EBC Pads: 409

ROTOR BOLT KITS AVAILABLE

HBK001	5 bolts in chrome finish 5/16 UNC - Front
HBK002	5 bolts in Black Chrome finish 5/16 UNC - Front
HBK003	5 bolts in chrome finish 3/8 UNC - Rear
HBK004	5 bolts in Black Chrome finish 3/8 UNC - Rear



ROTOR GROUP NO. 010 - FRONT. CHOOSE YOUR PREFERRED STYLE:

Type	Floating	OD	11.8" / 300mm
Color /Finish	Polished	Thickness	0.196" / 5mm
Bobbins	10	Bore	2.22" / 56.4mm
F/R	Front	Bolt Holes	Counterbored

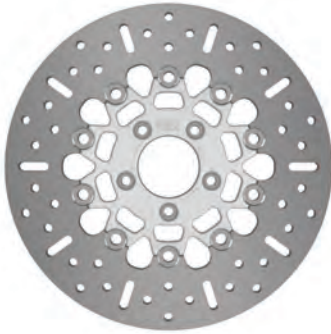

MD518
Fits EBC Pads: 400, 409, 457

Type	Floating	OD	11.8" / 300mm
Color /Finish	Black	Thickness	0.196" / 5mm
Bobbins	10	Bore	2.22" / 56.4mm
F/R	Front	Bolt Holes	Counterbored



MD518BLK
Fits EBC Pads: 400, 409, 457

Type	Floating	OD	11.8" / 300mm
Color /Finish	Black	Thickness	0.196" / 5mm
Bobbins	10	Bore	2.22" / 56.4mm
F/R	Front	Bolt Holes	Counterbored



MD518CBLK
Fits EBC Pads: 400, 409, 457

Type	Floating	OD	11.8" / 300mm
Color /Finish	Black	Thickness	0.196" / 5mm
Bobbins	10	Bore	2.22" / 56.4mm
F/R	Front	Bolt Holes	Plain



MD520/10BLK
Fits EBC Pads: 409

Type	Floating	OD	11.8" / 300mm
Color /Finish	Polished	Thickness	0.196" / 5mm
Bobbins	5	Bore	2.22" / 56.4mm
F/R	Front	Bolt Holes	Plain

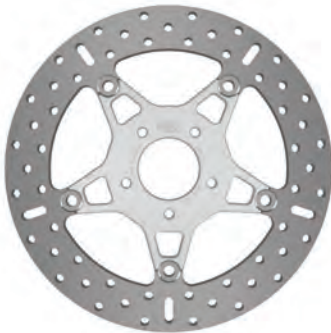

MD520
Fits EBC Pads: 296, 409, 638, 640

Type	Floating	OD	11.8" / 300mm
Color /Finish	Natural	Thickness	0.196" / 5mm
Bobbins	None	Bore	2.22" / 56.4mm
F/R	Front	Bolt Holes	Plain



VR520BLK
Fits EBC Pads: 409

Type	Solid	OD	11.8" / 300mm
Color /Finish	Natural	Thickness	0.196" / 5mm
Bobbins	None	Bore	2.22" / 56.4mm
F/R	Front	Bolt Holes	Counterbored



MD526
Fits EBC Pads: 296, 640

Type	Floating	OD	11.8" / 300mm
Color /Finish	Polished	Thickness	0.196" / 5mm
Bobbins	5	Bore	2.22" / 56.4mm
F/R	Front	Bolt Holes	Counterbored

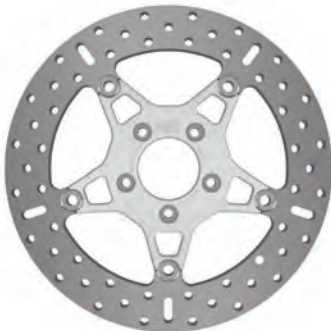

MD530
Fits EBC Pads: 296, 409, 638, 640

Type	Floating	OD	11.8" / 300mm
Color /Finish	Black	Thickness	0.196" / 5mm
Bobbins	5	Bore	2.22" / 56.4mm
F/R	Front	Bolt Holes	Counterbored



MD530BLK
Fits EBC Pads: 296, 638, 640

Type	Solid	OD	11.8" / 300mm
Color /Finish	Natural	Thickness	0.196" / 5mm
Bobbins	None	Bore	2.22" / 56.4mm
F/R	Front	Bolt Holes	Plain



MD541
Fits EBC Pads: 409

**5 button or
10 button
Floating Rotors**

**Light duty 5 button rotors are designed for bikes with a TWIN front rotor set up.
Heavy duty 10 button rotors are designed for bikes with a SINGLE front rotor set up.**

ROTOR GROUP NO. 010 - FRONT. CHOOSE YOUR PREFERRED STYLE:

Type	Floating	OD	14" / 355mm
Color /Finish	Polished	Thickness	0.196" / 5mm
Bobbins	5	Bore	2.22" / 56.4mm
F/R	Front	Bolt Holes	Counterbored

OVERSIZE ROTOR OPTION

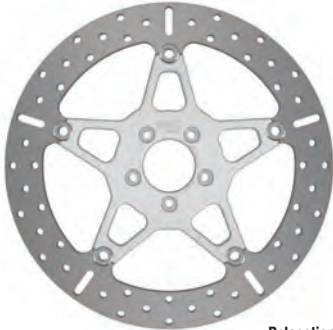

OSMD518-14
Fits EBC Pads: 400, 409, 457
BRK701 SEE RIGHT Relocation bracket & hardware available to purchase separately

Type	Floating	OD	14" / 355mm
Color /Finish	Black	Thickness	0.196" / 5mm
Bobbins	5	Bore	2.22" / 56.4mm
F/R	Front	Bolt Holes	Counterbored

OVERSIZE ROTOR OPTION

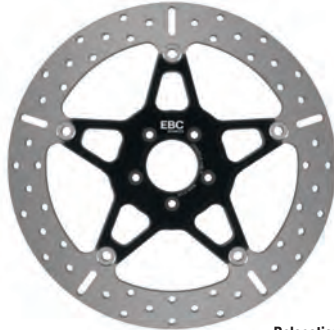

OSMD518-14BLK
Fits EBC Pads: 400, 409, 457
BRK701 SEE RIGHT Relocation bracket & hardware available to purchase separately

Increased stopping power, feel and control with the EBC FULLY floating oversize range. These kits bolt directly onto your bike using the stock caliper and also deliver the advantages of a floating rotor over solid designs.



BRK701

MD522

Type	Solid	OD	9.44" / 240mm
Color /Finish	Natural	Thickness	0.196" / 5mm
Bobbins	None	Bore	2.77" / 70.6mm
F/R	Rear	Bolt Holes	Plain

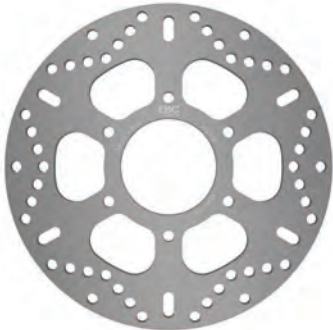

MD522
Fits EBC Pads: 140

ROTOR BOLT KITS AVAILABLE

HBK001	5 bolts in chrome finish 5/16 UNC - Front
HBK002	5 bolts in Black Chrome finish 5/16 UNC - Front
HBK003	5 bolts in chrome finish 3/8 UNC - Rear
HBK004	5 bolts in Black Chrome finish 3/8 UNC - Rear



ROTOR GROUP NO. 011 – REAR. CHOOSE YOUR PREFERRED STYLE:

Type	Solid	OD	10.23" / 260mm
Color /Finish	Natural	Thickness	0.275" / 7mm
Bobbins	None	Bore	2.22" / 56.4mm
F/R	Rear	Bolt Holes	Counterbored



MD524
Fits EBC Pads: 254, 387

Type	Floating	OD	10.23" / 260mm
Color /Finish	Polished	Thickness	0.275" / 7mm
Bobbins	10	Bore	2.22" / 56.4mm
F/R	Rear	Bolt Holes	Counterbored

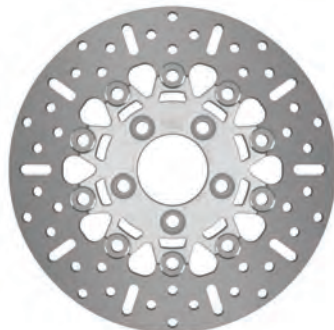

RSD524
Fits EBC Pads: 254, 387

ROTOR GROUP NO. 017 – FRONT. CHOOSE YOUR PREFERRED STYLE:

Type	Solid	OD	11.8" / 300mm
Color /Finish	Natural	Thickness	0.196" / 5mm
Bobbins	None	Bore	5.48" / 139.2mm
F/R	Front	Bolt Holes	N/A

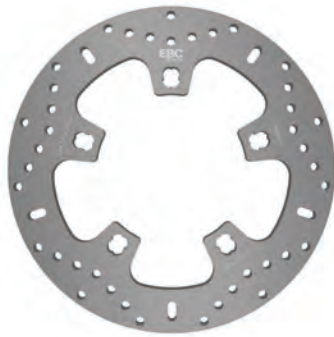

MD529
Fits EBC Pads: 409

Type	Solid	OD	11.8" / 300mm
Color /Finish	Natural	Thickness	0.196" / 5mm
Bobbins	None	Bore	5.48" / 139.2mm
F/R	Front	Bolt Holes	N/A



VR529
Fits EBC Pads: 409

MD531

MD532

Type	Solid	OD	11.5" / 290mm
Color /Finish	Natural	Thickness	0.196" / 5mm
Bobbins	None	Bore	2.22" / 56.4mm
F/R	Front	Bolt Holes	Plain



MD531
Fits EBC Pads: 643

Type	Solid	OD	10.23" / 260mm
Color /Finish	Natural	Thickness	0.196" / 5mm
Bobbins	None	Bore	2.22" / 56.4mm
F/R	Rear	Bolt Holes	Plain



MD532
Fits EBC Pads: 643

ROTOR GROUP NO. 019 – FRONT/REAR. CHOOSE YOUR PREFERRED STYLE:

Type	Solid	OD	11.8" / 300mm
Color /Finish	Black	Thickness	0.82" / 21mm
Bobbins	None	Bore	2.67" / 68mm
F/R	F/R	Bolt Holes	Plain



MD533
Fits EBC Pads: 669/4, 670

Type	Solid	OD	11.8" / 300mm
Color /Finish	Black	Thickness	0.82" / 21mm
Bobbins	None	Bore	2.67" / 68mm
F/R	F/R	Bolt Holes	Plain



MD533BSDF – Front 2 required
Fits EBC Pads: 669/4, 670

Type	Solid	OD	11.8" / 300mm
Color /Finish	Black	Thickness	0.82" / 21mm
Bobbins	None	Bore	2.67" / 68mm
F/R	F/R	Bolt Holes	Plain



MD533BSDR – Rear 1 required
Fits EBC Pads: 669/4, 670

BSDF and BSDR slotted sport rotors
choose axle required from suffix F for front
and R for rear)

ROTOR GROUP NO. 020 – FRONT/REAR. CHOOSE YOUR PREFERRED STYLE:

Type	Solid	OD	11.73" / 298mm
Color /Finish	Natural	Thickness	0.196" / 5mm
Bobbins	None	Bore	2.52" / 64.2mm
F/R	F/R	Bolt Holes	Plain



MD534
Fits EBC Pads: 209/2, 213, 377, 672

Type	Floating	OD	11.73" / 298mm
Color /Finish	Polished	Thickness	0.196" / 5mm
Bobbins	10	Bore	2.52" / 64.2mm
F/R	F/R	Bolt Holes	Plain

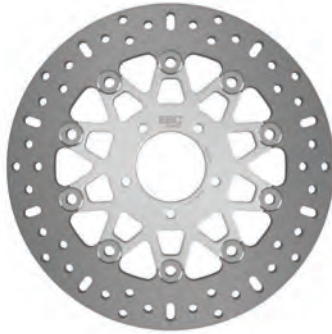

MD534X
Fits EBC Pads: 209/2, 213, 377, 672

Type	Floating	OD	11.73" / 298mm
Color /Finish	Polished	Thickness	0.196" / 5mm
Bobbins	10	Bore	2.52" / 64.2mm
F/R	F/R	Bolt Holes	Plain



MD534XBLK
Fits EBC Pads: 209/2, 213, 377, 672

ROTOR GROUP NO. 021 - FRONT/REAR. CHOOSE YOUR PREFERRED STYLE:

Type	Floating	OD	11.5" / 290mm
Color /Finish	Polished	Thickness	0.196" / 5mm
Bobbins	5	Bore	2.22" / 56.4mm
F/R	F/R	Bolt Holes	Counterbored

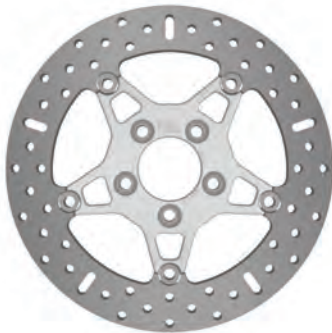

MD535
Fits EBC Pads: 95, 696

Type	Floating	OD	11.5" / 290mm
Color /Finish	Black	Thickness	0.196" / 5mm
Bobbins	5	Bore	2.22" / 56.4mm
F/R	F/R	Bolt Holes	Counterbored



MD535BLK
Fits EBC Pads: 95, 696

ROTOR GROUP NO. 022 – FRONT. CHOOSE YOUR PREFERRED STYLE:

Type	Solid	OD	11.8" / 300mm
Color /Finish	Natural	Thickness	0.236" / 6mm
Bobbins	None	Bore	2.22" / 56.4mm
F/R	Front	Bolt Holes	Counterbored



MD536
Fits EBC Pads: 209/2

Type	Floating	OD	11.8" / 300mm
Color /Finish	Polished	Thickness	0.236" / 6mm
Bobbins	5	Bore	2.22" / 56.4mm
F/R	Front	Bolt Holes	Counterbored

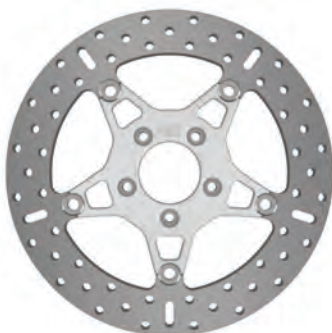

MD536X
Fits EBC Pads: 209/2

Type	Floating	OD	11.8" / 300mm
Color /Finish	Black	Thickness	0.236" / 6mm
Bobbins	5	Bore	2.22" / 56.4mm
F/R	Front	Bolt Holes	Counterbored



MD536XBLK
Fits EBC Pads: 209/2

MD537

Type	Solid	OD	11.8" / 300mm
Color /Finish	Natural	Thickness	0.236" / 6mm
Bobbins	None	Bore	2.22" / 56.4mm
F/R	Rear	Bolt Holes	Counterbored



MD537
Fits EBC Pads: 181

ROTOR BOLT KITS AVAILABLE

HBK001	5 bolts in chrome finish 5/16 UNC - Front
HBK002	5 bolts in Black Chrome finish 5/16 UNC - Front
HBK003	5 bolts in chrome finish 3/8 UNC - Rear
HBK004	5 bolts in Black Chrome finish 3/8 UNC - Rear



MD538

Type	Solid	OD	10.67" / 270.5mm
Color /Finish	Black	Thickness	0.236" / 6mm
Bobbins	None	Bore	4.311" / 109.5mm
F/R	Rear	Bolt Holes	Plain



MD538 – Cast iron rotors for Trikes®
Fits EBC Pads: 641/4

MD540

Type	Solid	OD	8.97" / 233mm
Color /Finish	Black	Thickness	0.236" / 6mm
Bobbins	None	Bore	6.783" / 172.3mm
F/R	Rear	Bolt Holes	Plain



MD540 – Cast iron rotors for Trikes®
Fits EBC Pads: 605/4

ROTOR GROUP NO. 024 - FRONT/REAR. CHOOSE YOUR PREFERRED STYLE:

Type	Floating	OD	11.8" / 300mm
Color /Finish	Natural	Thickness	0.196" / 5mm
Bobbins	9	Bore	2.52" / 64.2mm
F/R	F/R	Bolt Holes	Plain

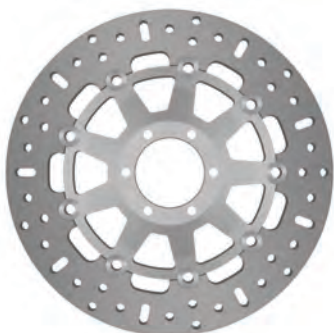

MD678
Fits EBC Pads: 196, 209/2, 244, 347

Type	Floating	OD	11.8" / 300mm
Color /Finish	Black	Thickness	0.196" / 5mm
Bobbins	9	Bore	2.52" / 64.2mm
F/R	F/R	Bolt Holes	Plain



MD678BLK
Fits EBC Pads: 196, 209/2, 244, 347

Type	Floating	OD	11.8" / 300mm
Color /Finish	Black	Thickness	0.196" / 5mm
Bobbins	9	Bore	2.52" / 64.2mm
F/R	F/R	Bolt Holes	Plain

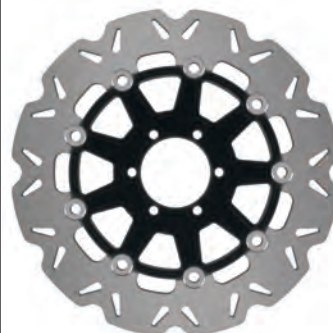

VR678BLK
Fits EBC Pads: 196, 209/2, 244, 347

ROTOR GROUP NO. 025 – REAR. CHOOSE YOUR PREFERRED STYLE:

Type	Floating	OD	11.8" / 300mm
Color /Finish	Black	Thickness	0.275" / 7mm
Bobbins	9	Bore	2.527" / 64.2mm
F/R	Rear	Bolt Holes	Plain



MD887BLK
Fits EBC Pads: 196

Type	Floating	OD	11.8" / 300mm
Color /Finish	Black	Thickness	0.275" / 7mm
Bobbins	9	Bore	2.527" / 64.2mm
F/R	Rear	Bolt Holes	Plain



VR887BLK
Fits EBC Pads: 196

ROTOR GROUP NO. 026 – FRONT/REAR. CHOOSE YOUR PREFERRED STYLE:

Type	Floating	OD	11.8" / 300mm
Color /Finish	Natural	Thickness	0.196" / 5mm
Bobbins	9	Bore	1.99" / 50.6mm
F/R	F/R	Bolt Holes	Plain

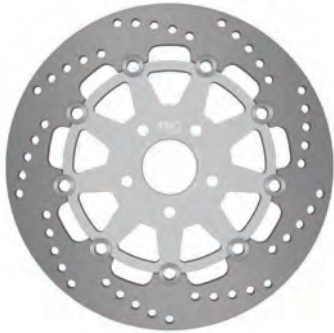

MD727
Fits EBC Pads: 209/2, 244

Type	Floating	OD	11.8" / 300mm
Color /Finish	Black	Thickness	0.196" / 5mm
Bobbins	9	Bore	1.99" / 50.6mm
F/R	F/R	Bolt Holes	Plain



VR727BLK
Fits EBC Pads: 209/2, 244

ROTOR GROUP NO. 027 - FRONT. CHOOSE YOUR PREFERRED STYLE:

Type	Solid	OD	9.84" / 250mm
Color /Finish	Natural	Thickness	0.236" / 6mm
Bobbins	None	Bore	2.606" / 66.2mm
F/R	Front	Bolt Holes	Plain



MD801
Fits EBC Pads: 474

Type	Solid	OD	9.84" / 250mm
Color /Finish	Natural	Thickness	0.236" / 6mm
Bobbins	None	Bore	2.606" / 66.2mm
F/R	Front	Bolt Holes	Plain



VR801
Fits EBC Pads: 474

ROTOR GROUP NO. 028 – REAR. CHOOSE YOUR PREFERRED STYLE:

Type	Solid	OD	9.84" / 250mm
Color /Finish	Natural	Thickness	0.236" / 6mm
Bobbins	None	Bore	2.606" / 66.2mm
F/R	Rear	Bolt Holes	Plain

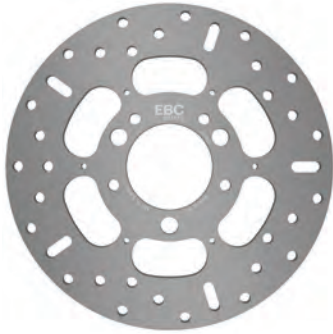

MD802
Fits EBC Pads: 473

Type	Solid	OD	9.84" / 250mm
Color /Finish	Natural	Thickness	0.236" / 6mm
Bobbins	None	Bore	2.606" / 66.2mm
F/R	Rear	Bolt Holes	Plain



VR802
Fits EBC Pads: 473

ROTOR GROUP NO. 029 – FRONT. CHOOSE YOUR PREFERRED STYLE:

Type	Solid	OD	10.6" / 270mm
Color /Finish	Natural	Thickness	0.275" / 7mm
Bobbins	None	Bore	2.46" / 62.6mm
F/R	Front	Bolt Holes	Plain



MD853
Fits EBC Pads: 630

Type	Solid	OD	10.6" / 270mm
Color /Finish	Natural	Thickness	0.275" / 7mm
Bobbins	None	Bore	2.46" / 62.6mm
F/R	Front	Bolt Holes	Plain



VR853
Fits EBC Pads: 630

ROTOR GROUP NO. 030 - REAR. CHOOSE YOUR PREFERRED STYLE:

Type	Solid	OD	10.6" / 270mm
Color /Finish	Natural	Thickness	0.275" / 7mm
Bobbins	None	Bore	2.46" / 62.6mm
F/R	Rear	Bolt Holes	Counterbored



MD854
Fits EBC Pads: 631

Type	Solid	OD	10.6" / 270mm
Color /Finish	Natural	Thickness	0.275" / 7mm
Bobbins	None	Bore	2.46" / 62.6mm
F/R	Rear	Bolt Holes	Counterbored



VR854
Fits EBC Pads: 631

ROTOR BOLT KITS AVAILABLE

HBK001	5 bolts in chrome finish 5/16 UNC - Front
HBK002	5 bolts in Black Chrome finish 5/16 UNC - Front
HBK003	5 bolts in chrome finish 3/8 UNC - Rear
HBK004	5 bolts in Black Chrome finish 3/8 UNC - Rear



ROTOR GROUP NO. 031 – FRONT.

ROTOR GROUP NO. 032 – REAR.

Type	Solid	OD	12.59" / 320mm
Color /Finish	Natural	Thickness	0.196" / 5mm
Bobbins	None	Bore	8.86" / 225mm
F/R	Front	Bolt Holes	N/A

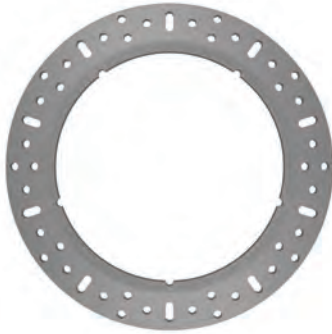

MD737
Fits EBC Pads: 196

Type	Solid	OD	12.59" / 320mm
Color /Finish	Natural	Thickness	0.196" / 5mm
Bobbins	None	Bore	8.86" / 225mm
F/R	Front	Bolt Holes	N/A



VR737
Fits EBC Pads: 196

Type	Solid	OD	8.66" / 220mm
Color /Finish	Natural	Thickness	0.196" / 5mm
Bobbins	None	Bore	1.99" / 50.6mm
F/R	Rear	Bolt Holes	Plain



MD738
Fits EBC Pads: 140

Type	Solid	OD	8.66" / 220mm
Color /Finish	Natural	Thickness	0.196" / 5mm
Bobbins	None	Bore	1.99" / 50.6mm
F/R	Rear	Bolt Holes	Plain



VR738
Fits EBC Pads: 140

MD689

MD690

MD690C

MD691

Type	Solid	OD	9.05" / 230mm
Color /Finish	Natural	Thickness	0.177" / 4.5mm
Bobbins	None	Bore	3.433" / 87.2mm
F/R	Rear	Bolt Holes	Counterbored



MD689
Fits EBC Pads: 86

Type	Floating	OD	11.8" / 300mm
Color /Finish	Natural	Thickness	0.157" / 4mm
Bobbins	9	Bore	2.527" / 64.2mm
F/R	Front	Bolt Holes	Counterbored

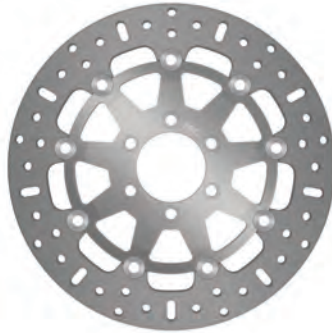

MD690
Fits EBC Pads: 86

Type	Floating	OD	11.8" / 300mm
Color /Finish	Natural	Thickness	0.157" / 4mm
Bobbins	9	Bore	2.527" / 64.2mm
F/R	Front	Bolt Holes	Counterbored

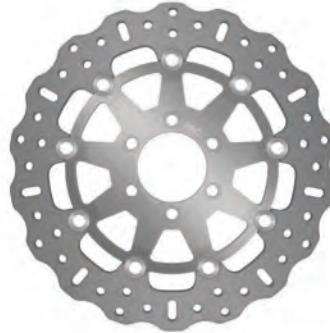

MD690C
Fits EBC Pads: 86

Type	Floating	OD	11.8" / 300mm
Color /Finish	Natural	Thickness	0.157" / 4mm
Bobbins	6	Bore	5.126" / 130.2mm
F/R	Front	Bolt Holes	Counterbored

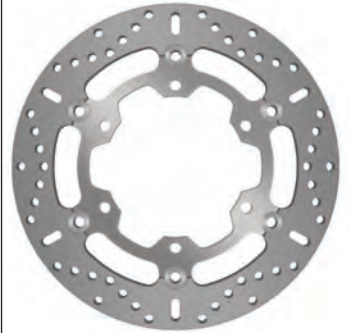

MD691
Fits EBC Pads: 86

MD719RS

MD734RS

MD735RS

MD803

Type	Floating	OD	13.38" / 340mm
Color /Finish	Natural	Thickness	0.196" / 5mm
Bobbins	9	Bore	2.385" / 60.6mm
F/R	Front	Bolt Holes	Countersunk



MD719RS
Fits EBC Pads: 210, 424

Type	Floating	OD	13.38" / 340mm
Color /Finish	Natural	Thickness	0.196" / 5mm
Bobbins	9	Bore	2.385" / 60.6mm
F/R	Front	Bolt Holes	Counterbored



MD734RS
Fits EBC Pads: 424

Type	Solid	OD	14.76" / 375mm
Color /Finish	Natural	Thickness	0.196" / 5mm
Bobbins	None	Bore	12" / 307mm
F/R	Front	Bolt Holes	N/A

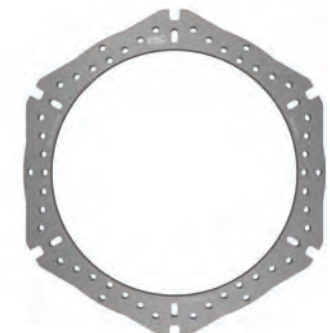

MD735RS
Fits EBC Pads: 345, 454/4

Type	Solid	OD	12.6" / 320mm
Color /Finish	Natural	Thickness	0.177" / 4.5mm
Bobbins	None	Bore	7.106" / 180.5mm
F/R	Front	Bolt Holes	Plain

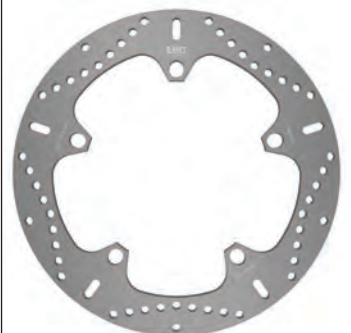

MD803
Fits EBC Pads: 630

MD890BLK

MD8007

MD1187C

MD6435C

Type	Floating	OD	11.8" / 300mm
Color /Finish	Black	Thickness	0.196" / 5mm
Bobbins	9	Bore	2.527" / 64.2mm
F/R	Front	Bolt Holes	Plain



MD890BLK
Fits EBC Pads: 196, 261, 347

Type	Solid	OD	10.24" / 260mm
Color /Finish	Natural	Thickness	0.196" / 5mm
Bobbins	None	Bore	4.63" / 117.6mm
F/R	Rear	Bolt Holes	Plain

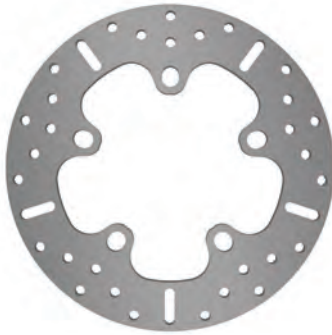

MD8007
Fits EBC Pads: 266

Type	Solid	OD	12.6" / 320mm
Color /Finish	Natural	Thickness	0.196" / 5mm
Bobbins	None	Bore	8.35" / 212.2mm
F/R	Front	Bolt Holes	Plain

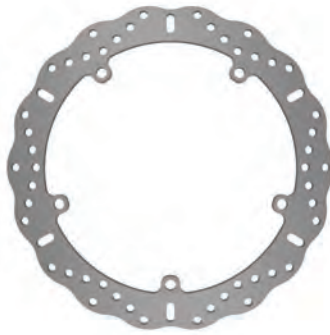

MD1187C
Fits EBC Pads: 185, 209/2, 264

Type	Solid	OD	9.44" / 240mm
Color /Finish	Natural	Thickness	0.157" / 4mm
Bobbins	None	Bore	4.141" / 105.2mm
F/R	Front	Bolt Holes	Plain

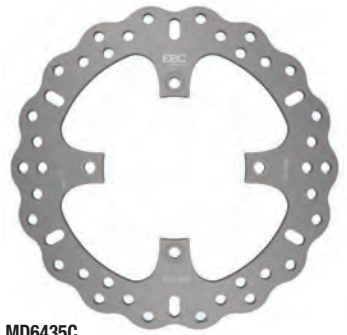

MD6435C
Fits EBC Pads: 83, 181, 185, 208, 209/2, 213, 264, 367

MD8018XBLK

MD8019

Type	Floating	OD	12.59" / 320mm
Color /Finish	Black	Thickness	0.177" / 4.5mm
Bobbins	5	Bore	2.244" / 57mm
F/R	Front	Bolt Holes	Plain



MD8018XBLK
Fits EBC Pads: 630

Type	Solid	OD	11.02" / 280mm
Color /Finish	Natural	Thickness	0.196" / 5mm
Bobbins	None	Bore	6.614" / 168mm
F/R	Rear	Bolt Holes	Plain

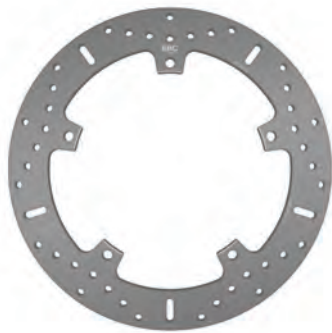

MD8019
Fits EBC Pads: 213

ROTOR BOLT KITS AVAILABLE

HBK001	5 bolts in chrome finish 5/16 UNC - Front
HBK002	5 bolts in Black Chrome finish 5/16 UNC - Front
HBK003	5 bolts in chrome finish 3/8 UNC - Rear
HBK004	5 bolts in Black Chrome finish 3/8 UNC - Rear



MD8020

MD8030

MD8031

Type	Solid	OD	12.59" / 320mm
Color /Finish	Natural	Thickness	0.177" / 4.5mm
Bobbins	None	Bore	6.322" / 160.6mm
F/R	Front	Bolt Holes	Elliptical

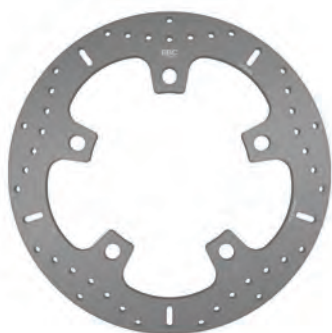

MD8020
Fits EBC Pads: 630

Type	Solid	OD	12.59" / 320mm
Color /Finish	Natural	Thickness	0.236" / 6mm
Bobbins	None	Bore	6.692" / 170mm
F/R	Front	Bolt Holes	Elliptical

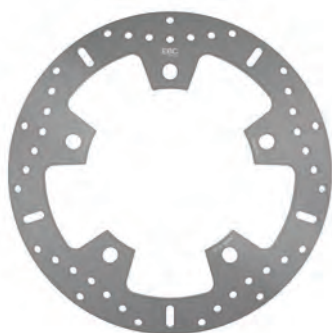

MD8030
Fits EBC Pads: 630

Need more braking power without going oversize



The EBC EPFA range have higher friction and therefore braking power and would be a great first attempt to boost brakes on a machine that lacks braking power at the front end.

Type	Solid	OD	10.24" / 260mm
Color /Finish	Natural	Thickness	0.196" / 5mm
Bobbins	None	Bore	5.315" / 135mm
F/R	Rear	Bolt Holes	Plain

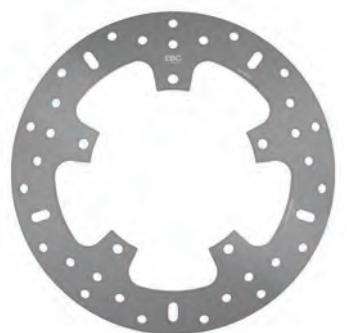

MD8031
Fits EBC Pads: 760

BRAKE LINES

EBC Brakes braided brake lines are manufactured in Great Britain from the highest quality materials, with braided stainless steel PTFE hose and grade 303 stainless steel precision machined fittings. At EBC Brakes we do not use mild steel or aluminum components in our brake lines, instead we choose stainless steel for every fitting, as this material offers maximum quality in terms of strength and corrosion resistance. EBC brake line kits are supplied 100% complete and include brand new stainless steel bolts and copper washers for maximum visuals.

EBC Brakes braided hoses fit many bikes in front, rear and race designs. Braided hoses improve brake pressure transfer to the caliper and Rotor pads, they help improve lever feel and reduce “bulging” which may happen with standard rubber hoses. Braided hoses are also more resistant to abrasion or cuts common with off road riding and thereby improve safety.

EBC brake lines are designed and built to last, that’s why every line is offered with a lifetime warranty. Every individual line is pressure tested after assembly and as an absolute guarantee of quality, EBC brake lines are manufactured to Federal Motor Vehicle Safety Standards (FMVSS-106) and have the following approvals: DOT, TÜV, ISO9001, DEKRA, ARAI, CCC AND ADR.

CAUTION – Check hose lengths carefully against parts being replaced and check carefully for pinch points and that hoses are not stretched at full handlebar lock position as this could cause hose leak and brake failure and an accident. EBC hoses are meant to replace standard length hoses and if your customer has changed to different size and shape bars these lines WILL NOT FIT and custom lines must be sourced.



ISO9001



DEKRA

ARAI



ADR

BLM is our standard braided hose series.

Hose numbers are suffixed with a number and letter designating the number of hoses in the kits and front or rear, for example;

BLM5000-1F is a kit with a single hose for front fitment

BLM5007-3F is a kit with three hoses for front fitment

BLM5002-2R is a kit with two hoses for rear fitment

HARLEY-DAVIDSON® BRAKE LINES

EBC Harley-Davidson® lines are supplied in a unique finish, with chromed stainless fittings, black hose and black/space-grey EBC Brakes heat shrink.

Additionally, where many competitors use ‘off the shelf’ components, EBC Harley-Davidson® lines are manufactured using our own bespoke design of chrome plated hardware and brackets, ensuring perfect fitment for complex Harley-Davidson® brake line assemblies.



BRAKE LINES



HARLEY-DAVIDSON®



		OE Replacement Brake Lines (Front)	OE Replacement Brake Lines (Rear)
DYNA			
FLD Switchback	2012-2014	BLM5000-1F	
FXD	1991-1999		BLM5049-2R
FXD	2000-2007		BLM5050-2R
FXD	2008-2013		BLM5051-1R
FXD/FXDC	2000-2005	BLM5052-1F	
FXD35 35th Anniversary	2006-2007	BLM5053-1F	
FXDB Dyna Daytona	1991-1992	BLM5054-3F	
FXDB-S Sturgis	1991-1992	BLM5055-1F	
FXDBI Street Bob	2006-2015	BLM5056-1F	
FXDC	2006-2014	BLM5057-1F	
FXDC Dyna Glide Custom	1990-1992	BLM5058-1F	
FXDC Dyna Glide Custom	1991-1992	BLM5054-3F	
FXDC/FXDCI Dyna Super Glide	2005	BLM5052-1F	
FXDF Dyna Fat Bob	2008-2015	BLM5061-3F	
FXDL Dyna Low Rider	1993-2000	BLM5054-3F	
FXDL Dyna Low Rider	2001-2005	BLM5063-1F	
FXDL Dyna Low Rider	2006-2013	BLM5000-1F	
FXDS-Con Dyna Low Rider Convertible	1993-2000	BLM5054-3F	
FXDWG Dyna Wide Glide	1993-2005	BLM5066-1F	
FXDWG Dyna Wide Glide	2006-2008	BLM5067-1F	
FXDWG Dyna Wide Glide	2010-2014	BLM5068-1F	
FXDX Super Glide Sport	1999-2005	BLM5069-3F	
FXDXT Dyna Super Glide	2001-2003	BLM5070-3F	
FXR	1987-1994		BLM5071-2R
FXR Super Glide	1987-1994	BLM5052-1F	
FXRS Low Rider Custom	1987-1994	BLM5074-1F	
FXRS-C Low Rider Convertible	1987-1994	BLM5075-3F	
FXRS-SP Low Rider Sport	1987-1994	BLM5076-3F	
FXRT Sport Glide Tourer	1987-1992	BLM5077-3F	
SOFTAIL			
FLS Softail Slim	2013-2015	BLM5018-1F	
FLS Softail Slim	2017-2018	BLM5120-1F	
FLST	2008-2013		BLM5019-2R
FLST Fat Boy	1984-1999		BLM5020-2R
FLST Fat Boy	2000-2006		BLM5021-2R
FLST Heritage	2007		BLM5023-2R
FLST Heritage	1984-1990	BLM5022-1F	
FLST-SB Cross Bones	2010-2011	BLM5024-1F	
FLSTC	2011-2015	BLM5025-1F	
FLSTC Heritage Classic	2011-2015	BLM5026-2F	
FLSTC Heritage Softail Classic	1987-2008	BLM5022-1F	
FLSTC Heritage Softail Classic	2009-2012	BLM5028-1F	
FLSTF	2011	BLM5029-1F	
FLSTF Fat Boy	2007		BLM5031-2R
FLSTF Fat Boy	1990-2011	BLM5022-1F	
FLSTF Fatboy	2011	BLM5032-2F	
FLSTF/FLSTFB/FLSTF	2012-2013	BLM5018-1F	
FLSTF/FLSTN/FLSTB/FLS ABS	2012-2016	BLM5034-1F	
FLSTF/FLSTN/FLSTFB/FLS ABS	2012-2016	BLM5035-2F	
FLSTFB ABS	2011	BLM5036-1F	
FLSTFB Fatboy Low ABS	2011	BLM5037-2F	

FRONT

REAR

BRAKE LINES



HARLEY-DAVIDSON®



		OE Replacement Brake Lines (Front)	OE Replacement Brake Lines (Rear)
FLSTN Softail Deluxe	2005-2013	BLM5018-1F	
FLSTN Softail Deluxe ABS	2011-2012	BLM5035-2F	
FLSTS Heritage Softail	1997-2003	BLM5040-1F	
FLSTSC Heritage Softail Classic	2005-2007	BLM5041-1F	
FXCW/FXCWC Softail Rocker	2008-2011	BLM5046-1F	
FXCWC ABS	2011	BLM5047-1F	
FXCWC Rocker ABS	2011	BLM5048-2F	
FXLR Low Rider Custom Low Bars	1987-1994	BLM5072-1F	
FXS Blackline	2011-2013	BLM5078-1F	
FXSB Breakout	2011-2014		
FXSB Breakout	2015-2017		
FXSB Breakout ABS	2014-2015	BLM5079-1F	
FXST	1984-1999		BLM5080-2R
FXST	2000-2005		BLM5021-2R
FXST ABS	2011-2015	BLM5082-1F	
FXST Softail	1984-1990	BLM5083-1F	
FXST Softail Standard	1999-2012	BLM5083-1F	
FXST/FXCW	2008-2013		BLM5019-2R
FXST/FXSTB/FXSTC	2007		BLM5031-2R
FXST/FXSTS/FXSTB	2006		BLM5087-2R
FXSTB Softail Night Train	1999-2009	BLM5088-1F	
FXSTC Softail Custom	1987-1999	BLM5083-1F	
FXSTC Softail Custom	2007-2010	BLM5090-1F	
FXSTD	2007		BLM5023-2R
FXSTD	2000-2006		BLM5021-2R
FXSTD Deuce	2000-2007	BLM5093-1F	
FXSTS Springer Softail	1987-2006	BLM5094-1F	
FXSTSB Bad Boy	1995-1997	BLM5095-1F	
SPORTSTER			
XL 50	2007	BLM5112-1F	BLM5105-2R
XL All Models	2004-2013		BLM5105-2R
XL All Models	1987-2003		BLM5106-2R
XL 883 Custom	2004-2010	BLM5112-1F	BLM5105-2R
XL 883 Custom	1996-2003	BLM5108-1F	BLM5106-2R
XL 883 Deluxe	1987-1991	BLM5108-1F	BLM5106-2R
XL 883 Deluxe	1992-2003	BLM5111-1F	BLM5106-2R
XL 883 R	2004-2013	BLM5109-3F	BLM5105-2R
XL 883 R	2002-2003	BLM5126-3F	BLM5106-2R
XL 883 Standard	2004-2009	BLM5113-1F	BLM5105-2R
XL 883 Standard	1987-2003	BLM5108-1F	BLM5106-2R
XL 883L Low	2005-2015	BLM5115-1F	
XL 883 N Iron	2010-2013	BLM5113-1F	BLM5105-2R
XL 883 N Iron	2014-2015	BLM5119-1F	
XL 1200 Classic	1996-2003	BLM5107-1F	BLM5106-2R
XL 1200 Custom	1996-2003	BLM5108-1F	BLM5106-2R
XL 1200 R	2004-2011	BLM5109-3F	BLM5105-2R
XL 1200 Sport	1996-2003	BLM5110-3F	BLM5106-2R
XL 1200 Sportster	1988-2003	BLM5111-1F	BLM5106-2R
XL 1200C	2004-2013	BLM5112-1F	BLM5105-2R
XL 1200C/XL 1200CP	2012-2013	BLM5113-1F	BLM5105-2R
XL 1200 CP	2012	BLM5114-1F	BLM5105-2R
XL 1200 L Low	2007-2011	BLM5115-1F	BLM5105-2R

FRONT

REAR

BRAKE LINES



HARLEY-DAVIDSON®



		OE Replacement Brake Lines (Front)	OE Replacement Brake Lines (Rear)
XL 1200 N Nightster	2008-2012	BLM5112-1F	BLM5105-2R
XL 1200 V Seventy Two	2012-2015	BLM5117-1F	
XL 1200 X Forty Eight	2012-2013	BLM5118-1F	BLM5105-2R
XL 1200 X Forty Eight	2014-2015	BLM5119-1F	
TOURING			
FLH/FLT	1992-1996		BLM5002-2R
FLH/FLT	1997-2007		BLM5003-2R
FLH/FLT	2008-2013		BLM5004-1R
FLH/FLT	2008-2013	BLM5007-3F	
FLH/FLT	2009-2013	BLM5005-1F	
FLH/FLT	2014-2016	BLM5006-1F	
FLH/FLT Except FLTR ABS	2009-2013	BLM5001-4F	
FLHR	2014-2015	BLM5009-3F	
FLHR Road King	2008	BLM5008-4F	
FLHR/FLHR-I Road King	1994-2007	BLM5010-3F	
FLHR/FLHRC	2008	BLM5011-1F	
FLHRC Road King Classic	1999-2007	BLM5010-3F	
FLHRS/FLHRSI Road King	2004-2007	BLM5013-3F	
FLHT/FLHTC/FLHTCU Electra Glide	1996-2007	BLM5014-3F	
FLHT/FLHTC/FLHTCU/FLHX	2008	BLM5015-4F	
FLHX	2014-2015	BLM5009-3F	
FLHX Street Glide	2006-2007	BLM5014-3F	
FLTR Road Glide ABS	2008-2013	BLM5042-4F	
FLTR/FLTR-I Road Glide	1998-2007	BLM5010-3F	
FLTRX/FLTRXS	2015	BLM5045-3F	
FLTRX/FLTRXS ABS	2015	BLM5044-1F	
V-ROD			
VRCSAW V-Rod	2008-2010	BLM5096-3F	
VRCSA/VRSCX V-Rod	2004-2005	BLM5098-3F	
VRCSA/VRSCX V-Rod	2006-2008	BLM5097-3F	
VRSCA V-Rod	2001-2005	BLM5099-3F	
VRSCA V-Rod	2006-2007	BLM5096-3F	
VRSCDX	2012	BLM5101-3F	
VRSCDX 10 Year Anniversary	2012-2013	BLM5097-3F	
VRSCDX Night Rod	2008-2011	BLM5097-3F	
VRSCF V-Rod Muscle	2009-2013	BLM5104-3F	

FRONT

REAR

EBC BRAKES CLUTCH KITS



SRC/SRK SERIES

The SRC series clutch kits include an aramid fibre lined facing for better heat and wear resistance. Plates should be smeared with drive case oil before install.

The SRK kits include a full set of friction plates lined with a carbon fiber based facing for even higher heat specs and also include new steel separator plates and a set of uprated springs hence a complete rebuild kit. Smear plates with drive case oil before install.



CK/CKF SERIES

These kits are a full engine set, measured to re-set the original "stack" height of the clutch. The plates are a moulded OEM style fiber bonded onto a steel backing. See your owners manual on oil type and install instructions to avoid clutch burn up or slippage.

The upgraded CKF range are again a full OEM size replacement friction plate only clutch pack but use a higher heat resistant carbon fiber impregnated facing. Smear plates with drive case oil before install.

Refer to EBC Brakes Clutch Kits listings for Motorcycle Model and Part No.
Box contents may vary.

Key Guide

CK – Full engine friction plate set similar to OEM (cork based material)

SRC – Full engine aramid fibre lined friction plate set with springs

SRK – Full engine aramid heavy duty friction plate set with steel driven plates and springs

EBC BRAKES CLUTCH KITS

CSK SERIES CLUTCH SPRING KITS

CSK sets include either coil springs or diaphragm springs where appropriate.



COIL SPRINGS

Coil springs are spiral wound with 4 to 10 pieces per set, made from heat treated high carbon steel delivering the right tension for your bike to avoid clutch slip. Springs always get tired after time and can promote clutch slip so when replacing the clutch - always replace the springs.

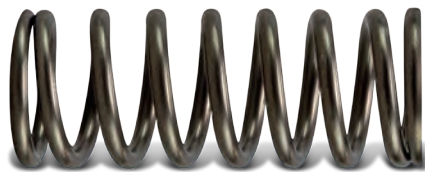

CSK Spring Kit #	Spring Length # mm	Spring Outer Diameter # mm	Spring Inner Diameter # mm	Quantity per pack
CSK230	47.21	20.04	14.87	4
CSK232	45.31	21.27	15.43	5
CSK233	43.44	20.81	15.51	4
CSK235	45.15	21.16	15.10	3
CSK236	46.70	21.20	15.30	3
CSK255	44.24	15.49	10.93	10
CSK257 -Big Coil	60.99/62.26	66.79/79.87	54.85/67.57	1

DIAPHRAGM SPRINGS

Diaphragm springs are dish shaped flat high carbon heat treated steel pressure rings made in the EBC UK pressworks.



CSK Diaphragm Spring Kit #	Spring Height # mm	Spring Outer Diameter # mm	Spring Inner Diameter # mm	Quantity per pack
CSK913	9.15	132.91	59.98	1
CSK914	9.25	145.78	61.01	1
CSK915	10.75	145.81	61.66	1
CSK916	10.40	145.88	61.38	1
CSK917	10.72	145.63	61.67	1
CSK918	6.97	132.88	59.75	1
CSK919	6.49	132.88	59.50	1
CSK920	6.85	132	60	1
CSK921	4.65	93	60.6	1

EBC BRAKES CLUTCH KITS

CK7002
CK7007

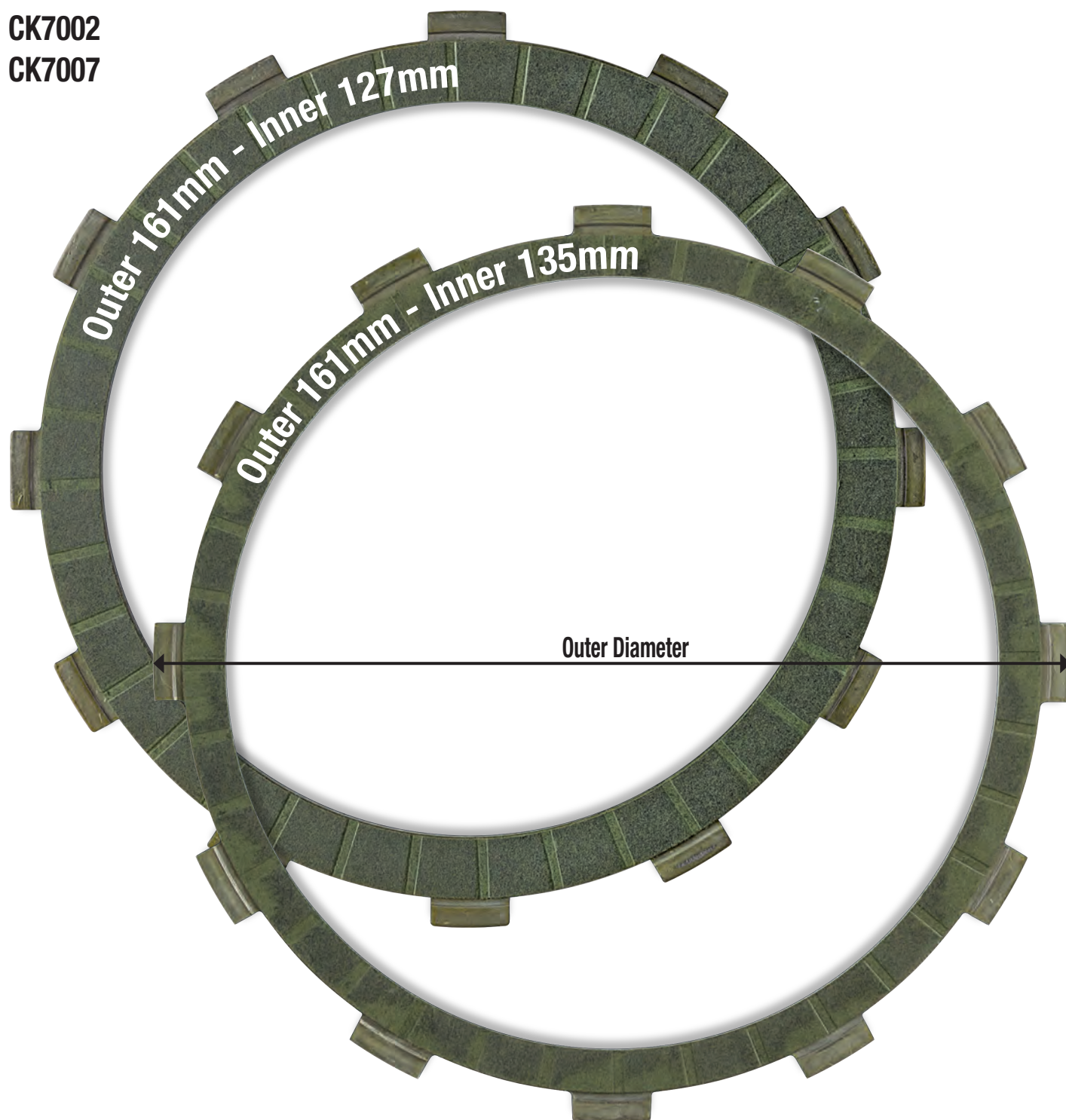

CK Series #	Dimensions and plate quantity. Outer Diameter - O/D Inner Diameter - I/D	CSK Spring Kit #	SRC Series Kit #	SRK Series Kit #	CT Clutch Tools #
CK7002	O/D=161mm-I/D=127mm x 6 plates. O/D=161mm-I/D=135mm x 3 plates	CSK235	SRC7003	SRK7003	CT702SP
CK7007	O/D=161mm-I/D=127mm x 7 plates. O/D=161mm-I/D=135mm x 3 plates	CSK236	SRC7008	SRK7008	CT708SP
CK7002	O/D=161mm-I/D=127mm x 6 plates. O/D=161mm-I/D=135mm x 3 plates	CSK236	SRC7010	SRK7010	CT702SP

EBC BRAKES CLUTCH KITS

CK7004

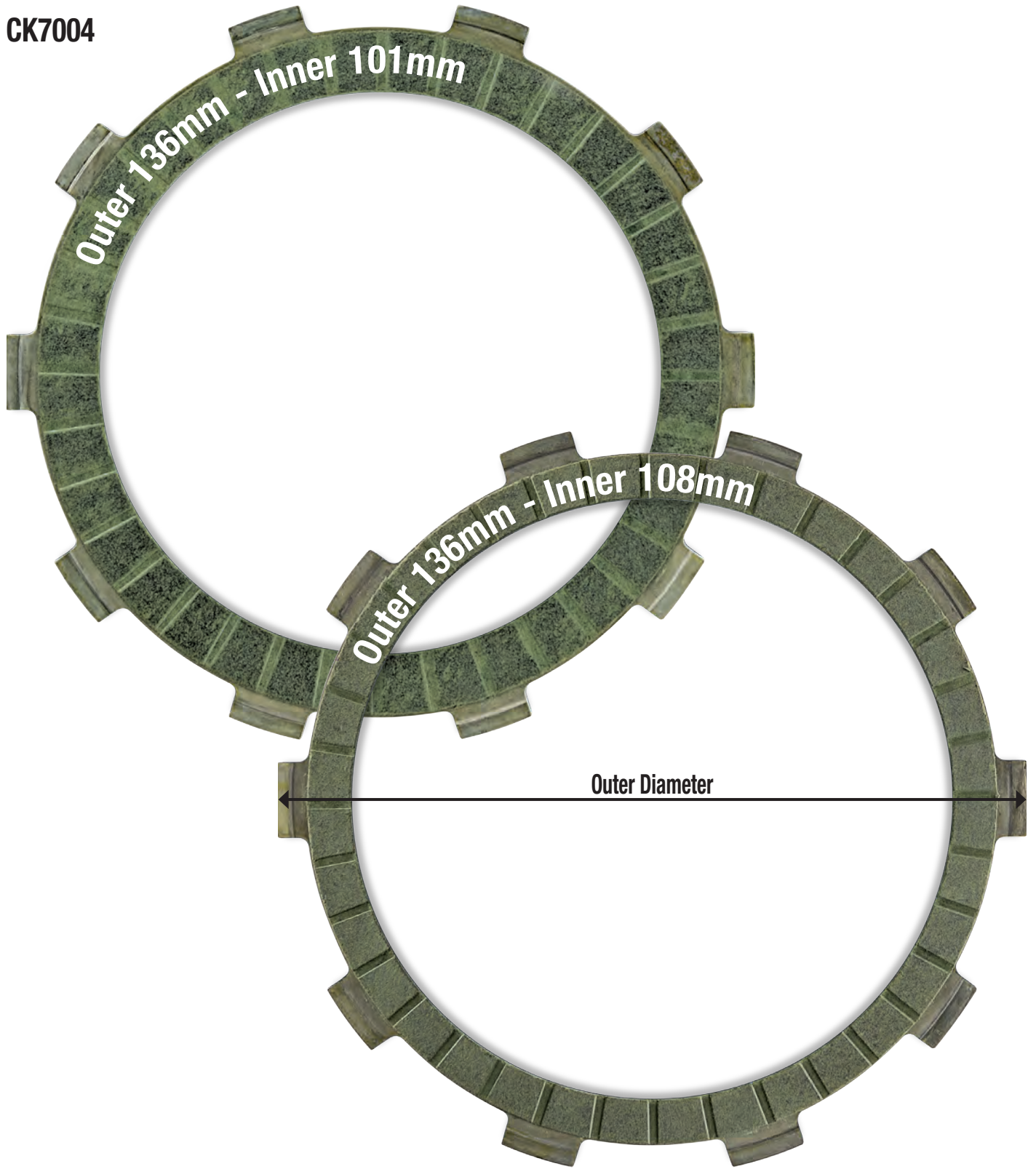

CK Series #	Dimensions and plate quantity. Outer Diameter - O/D Inner Diameter - I/D	CSK Spring Kit #	SRC Series Kit #	SRK Series Kit #	CT Clutch Tools #
CK7004	O/D=136mm-I/D=101mm x 7 plates. O/D=136mm-I/D=108mm x 1 plates.	CSK230	SRC7005	SRK7005	N/A

EBC BRAKES CLUTCH KITS

CK7009

CK7013

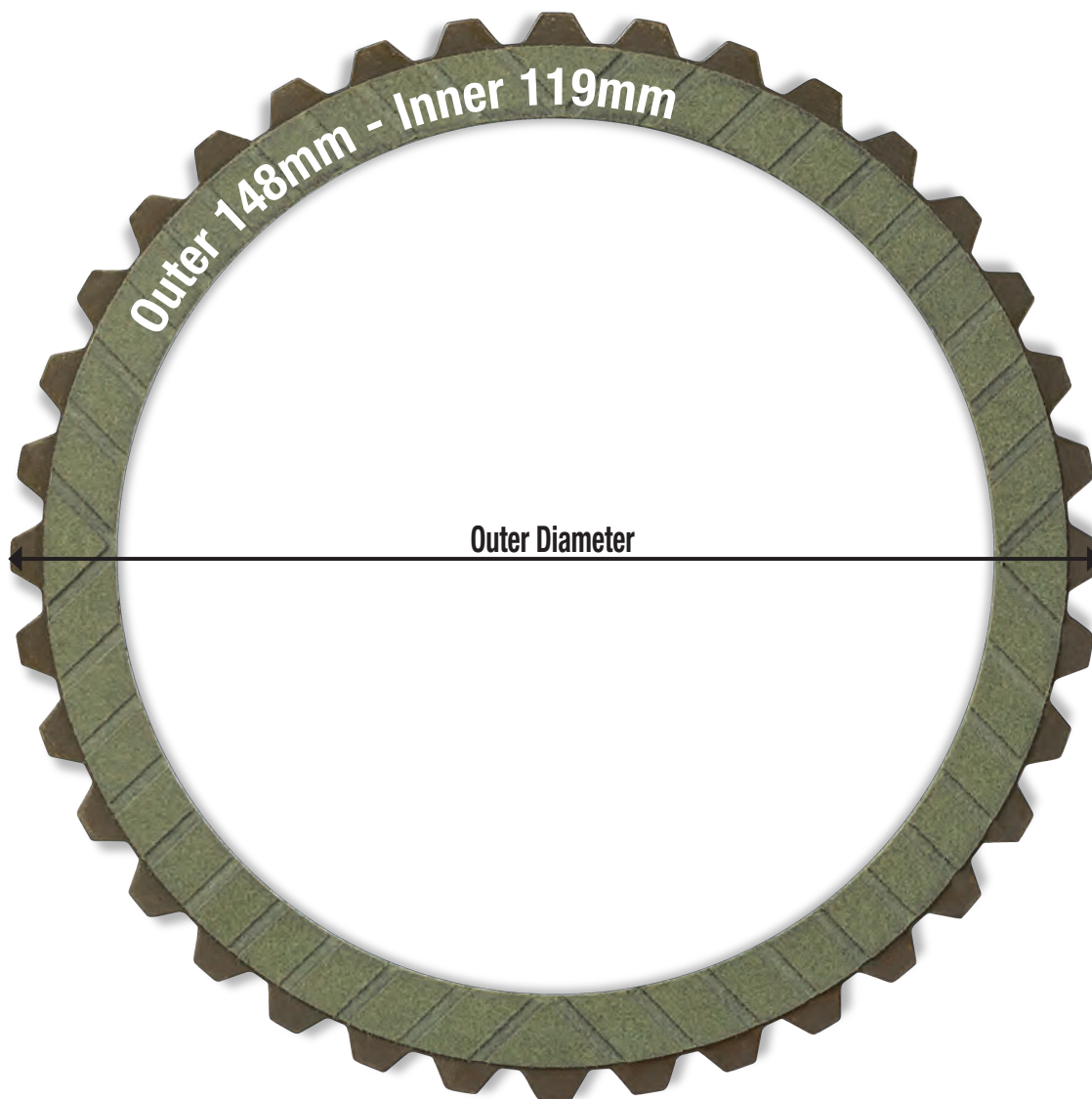

CK Series #	Dimensions and plate quantity. Outer Diameter - O/D Inner Diameter - I/D	CSK Spring Kit #	SRC Series Kit #	SRK Series Kit #	CT Clutch Tools #
CK7009	O/D=148mm-I/D=119mm x 8 plates.		SRC7014	SRK7014	CT701SP
CK7009	O/D=148mm-I/D=119mm x 8 plates.	CSK913	SRC7015	SRK7015	CT701SP
CK7009	O/D=148mm-I/D=119mm x 8 plates.		SRC7019	SRK7019	CT701SP
CK7009	O/D=148mm-I/D=119mm x 8 plates.	CSK919	SRC7020	SRK7020	CT701SP
CK7009	O/D=148mm-I/D=119mm x 8 plates.	CSK918	SRC7021	SRK7021	CT701SP
CK7009	O/D=148mm-I/D=119mm x 8 plates.	CSK920	SRC7023	SRK7023	CT701SP
CK7013	O/D=148mm-I/D=119mm x 8 plates.	CSK913	SRC7022	SRK7022	CT701SP

EBC BRAKES CLUTCH KITS

CK7010

CK7015

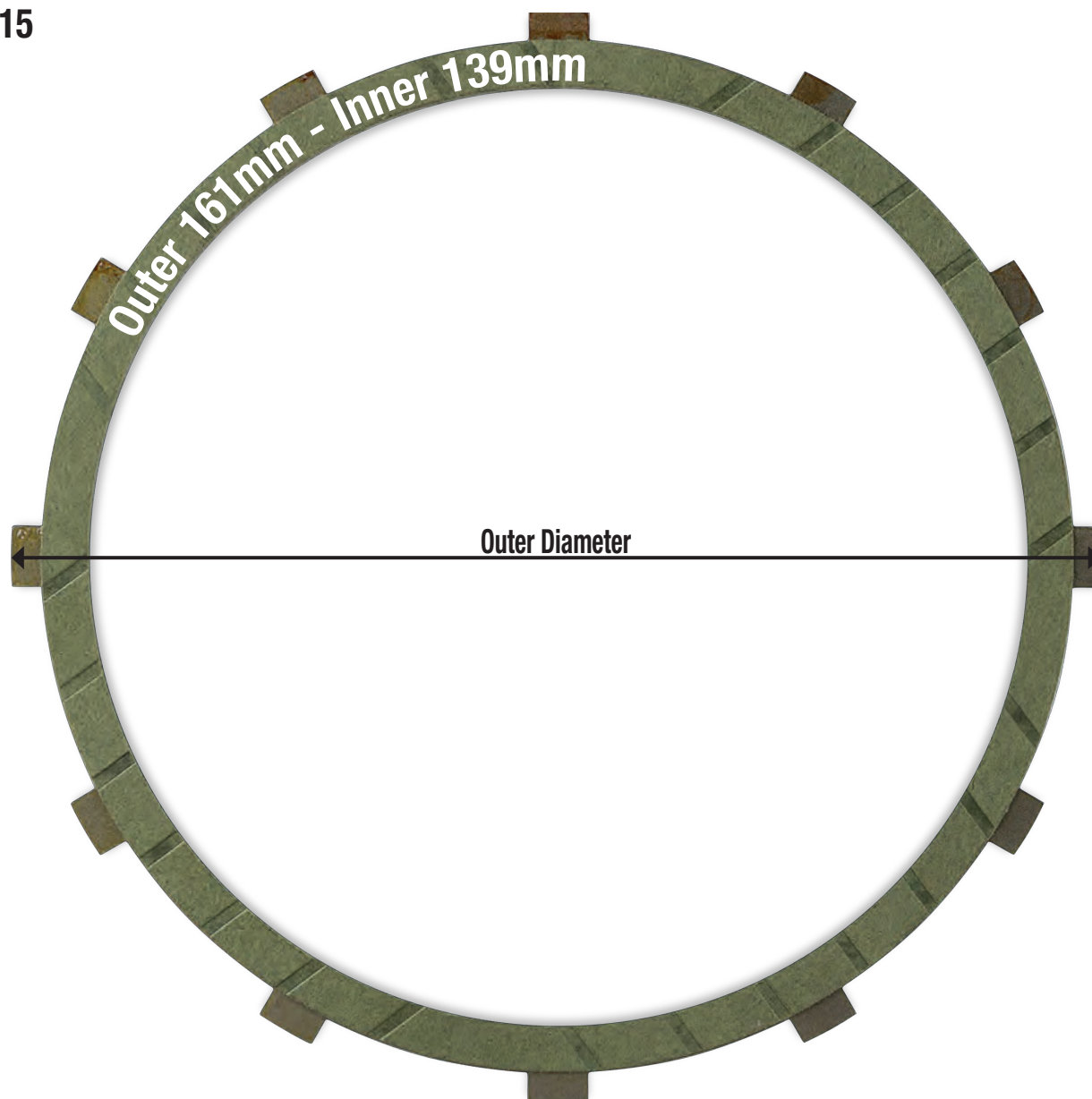

CK Series #	Dimensions and plate quantity. Outer Diameter - O/D Inner Diameter - I/D	CSK Spring Kit #	SRC Series Kit #	SRK Series Kit #	CT Clutch Tools #
CK7010	O/D=161mm-I/D=139mm x 6 plates.	CSK919	SRC7016	SRK7016	CT705SP
CK7015	O/D=161mm-I/D=139mm x 9 plates.	Big coil CSK257	SRC7025	SRK7025	CT701SP

EBC BRAKES CLUTCH KITS

CK7011
CK7012

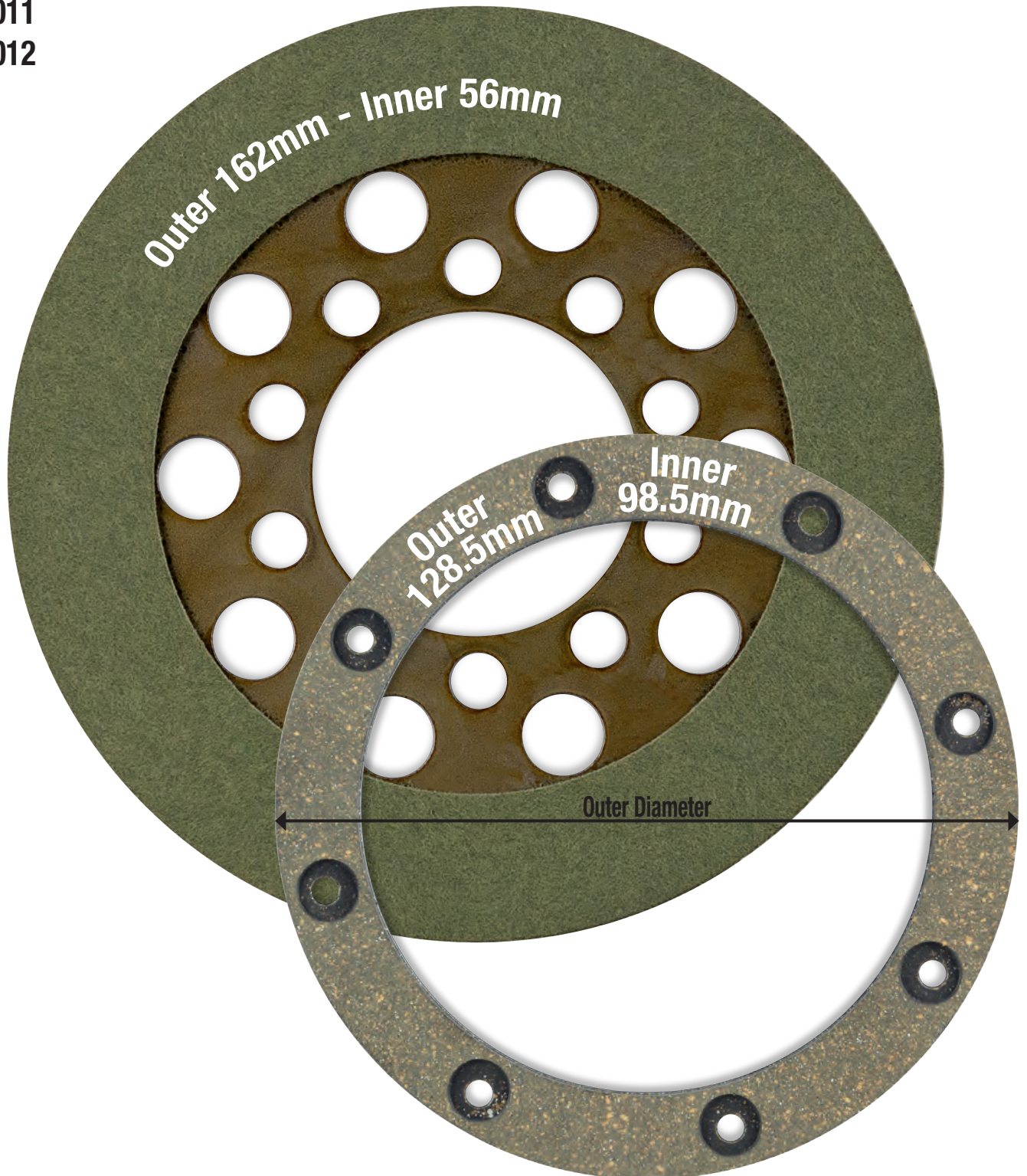

CK Series #	Dimensions and plate quantity. Outer Diameter - O/D Inner Diameter - I/D	CSK Spring Kit #	SRC Series Kit #	SRK Series Kit #	CT Clutch Tools #
CK7011	O/D=162mm-I/D=56mm x 5 plates.	CSK255	SRC7017	SRK7017	CT704SP
CK7012	O/D=162mm-I/D=56mm x 5 plates. O/D=128.5mm-I/D=98.5 x 1 plate.	CSK255	SRC7018	SRK7018	CT704SP

EBC BRAKES CLUTCH KITS

CK7005
CK7006

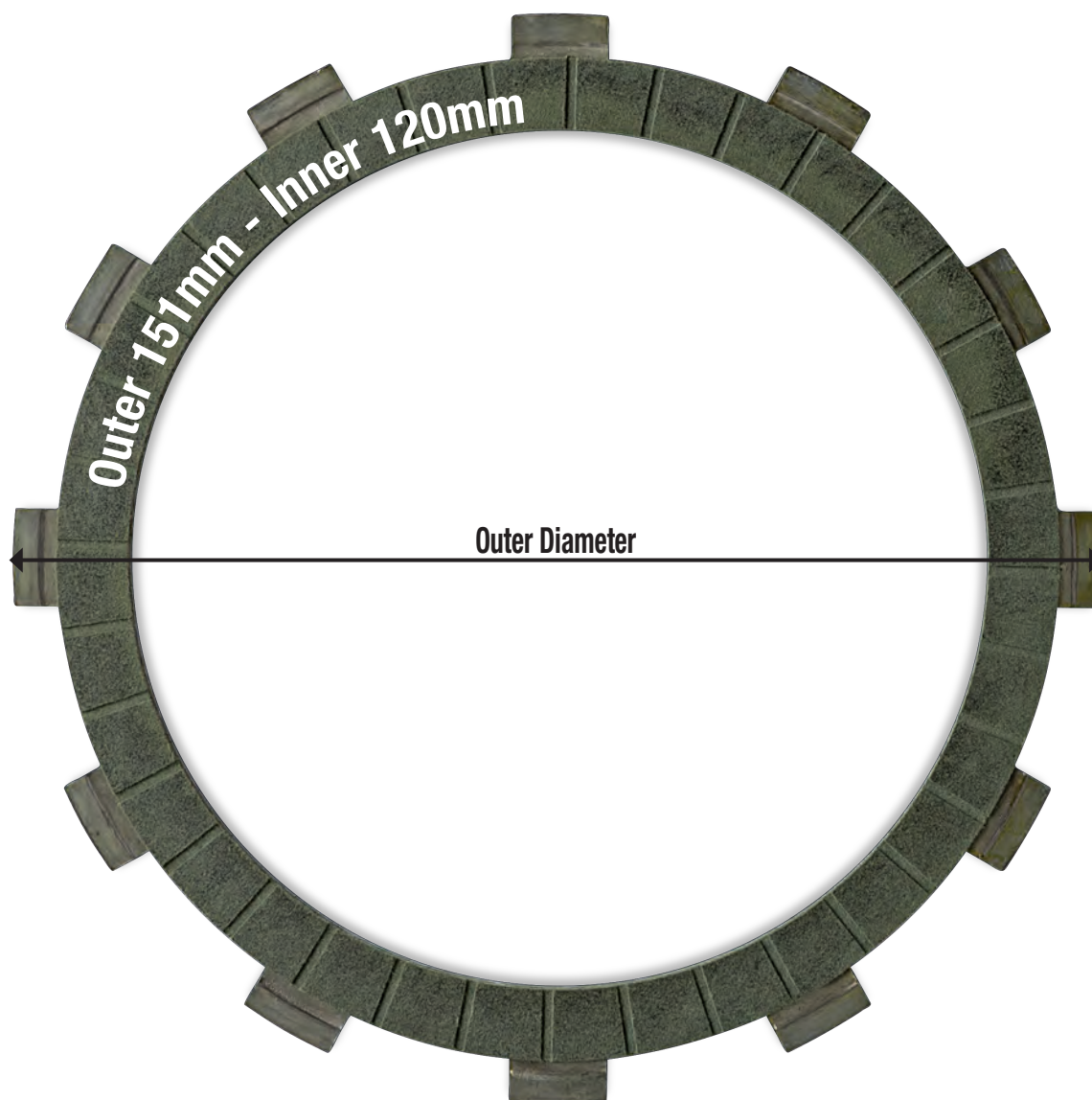

CK Series #	Dimensions and plate quantity. Outer Diameter - O/D Inner Diameter - I/D	CSK Spring Kit #	SRC Series Kit #	SRK Series Kit #	CT Clutch Tools #
CK7005	O/D=151mm-I/D=120mm x 9 plates.	CSK233	SRC7006	SRK7006	CT706SP
CK7006	O/D=151mm-I/D=120mm x 9 plates.	CSK232	SRC7007	SRK7007	CT706SP

EBC BRAKES CLUTCH KITS

CK7008
CK7014

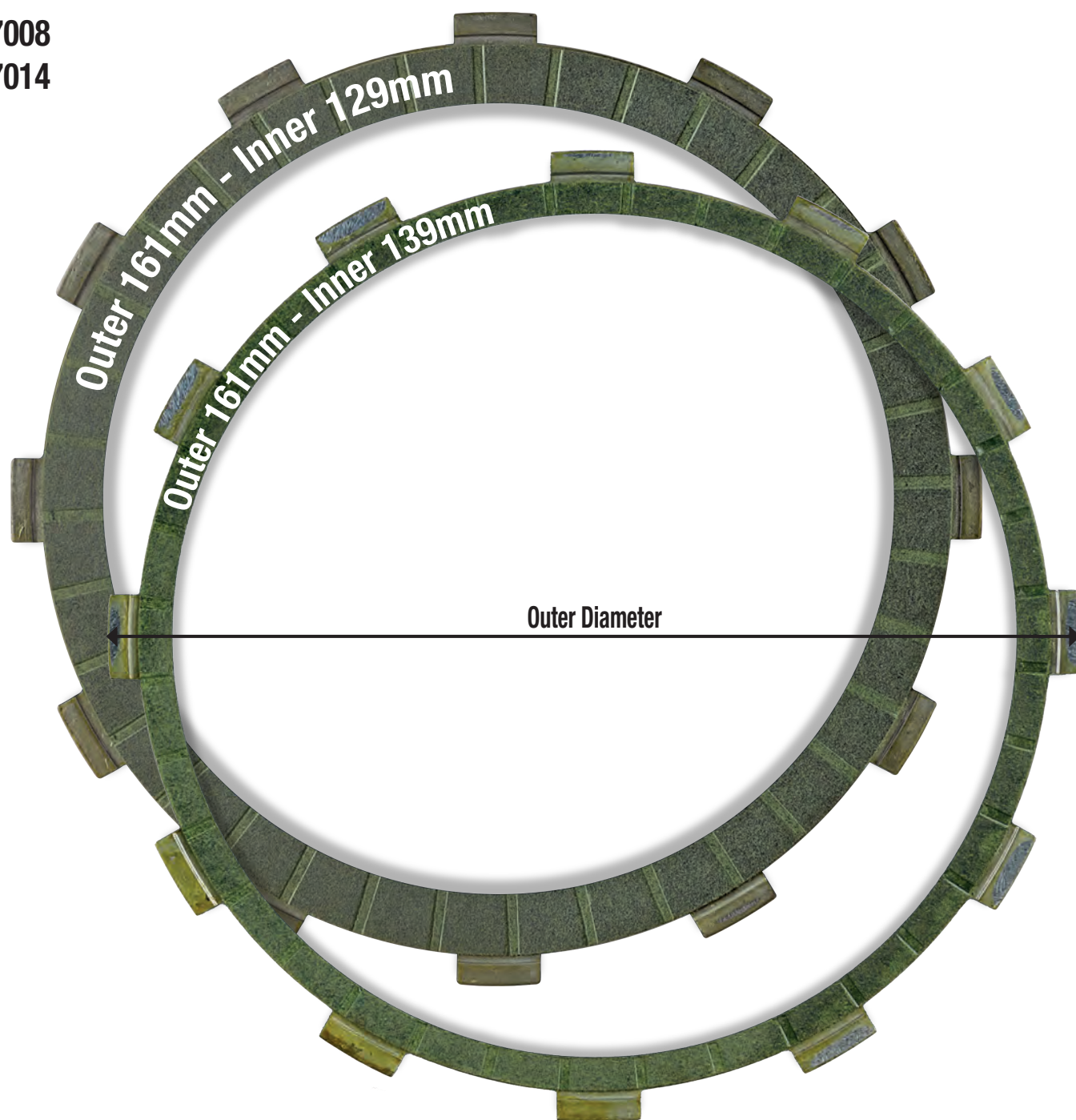

CK Series #	Dimensions and plate quantity. Outer Diameter - O/D Inner Diameter - I/D	CSK Spring Kit #	SRC Series Kit #	SRK Series Kit #	CT Clutch Tools #
CK7008	O/D=161mm-I/D=129mm x 8 plates. O/D=161mm-I/D=139 x 1 plate.	GSK914	SRC7009	SRK7009	CT703SP
CK7008	O/D=161mm-I/D=129mm x 8 plates. O/D=161mm-I/D=139 x 1 plate.	GSK917	SRC7011	SRK7011	CT703SP
CK7008	O/D=161mm-I/D=129mm x 8 plates. O/D=161mm-I/D=139 x 1 plate.	GSK916	SRC7012	SRK7012	CT703SP
CK7008	O/D=161mm-I/D=129mm x 8 plates. O/D=161mm-I/D=139 x 1 plate.	GSK915	SRC7013	SRK7013	CT703SP
CK7014	O/D=161mm-I/D=129mm x 7 plates.	GSK921	SRC7024	SRK7024	CT701SP

CT CLUTCH REMOVAL TOOLS

Made in the UK, these laser cut clutch removal tools make clutch removal, loosening of the drive shaft bolts and re-tightening a breeze, without any fear of damage to your expensive clutch basket.

Tools can be extended to create more leverage if required with any simple workshop tool or tube. EBC Brakes produce a clutch tool for almost every clutch plate design known.



CAUTION: replacing a clutch kit requires skill, expertise and a good workshop, plus tools. A small press and a spring compressor may be needed. If you are not familiar with these routines, use a competent dealer or visit www.fixmyhog.com as an example of how to guide you safely.

EBC BRAKES CLUTCH KITS



HARLEY-DAVIDSON®



		CK Series Moulded OEM style facings #	GSK Spring Kit #	SRC Series Kit #	SRK Series Kit #	CT Tool #
SPORTSTER						
XL 1200 C 1CT3 Custom	2007-2020	CK7009	CSK919	SRC7020	SRK7020	CT701SP
XL 1200 CB 1LK3 Custom Limited B	2013-2017	CK7009	CSK919	SRC7020	SRK7020	CT701SP
XL 1200 CP Custom H-D1	2011-2016	CK7009	CSK919	SRC7020	SRK7020	CT701SP
XL 1200 CX 3LM3 Roadster	2016-2020	CK7009	CSK919	SRC7020	SRK7020	CT701SP
XL 1200 Forty Eight Anniversary	2018	CK7009	CSK919	SRC7020	SRK7020	CT701SP
XL 50 1CY3 50th Anniversary Sportster	2007	CK7009	CSK919	SRC7020	SRK7020	CT701SP
XL1200	1991-2003	CK7009	CSK920	SRC7023	SRK7023	CT701SP
XL1200C 1CGP Custom	2004-2006	CK7009	CSK919	SRC7020	SRK7020	CT701SP
XL1200C Custom	1996-2003	CK7009	CSK920	SRC7023	SRK7023	CT701SP
XL1200CA 1LJ3 Custom Limited A	2013-2016	CK7009	CSK919	SRC7020	SRK7020	CT701SP
XL1200CANV Custom Anniversary	2013	CK7009	CSK919	SRC7020	SRK7020	CT701SP
XL1200L Low	2006-2011	CK7009	CSK919	SRC7020	SRK7020	CT701SP
XL1200N Nightster	2007-2012	CK7009	CSK919	SRC7020	SRK7020	CT701SP
XL1200NS 1LP3 Iron 1200	2018-2021	CK7009	CSK919	SRC7020	SRK7020	CT701SP
XL1200R Roadster	2004-2009	CK7009	CSK919	SRC7020	SRK7020	CT701SP
XL1200S Sport	1996-2003	CK7009	CSK920	SRC7023	SRK7023	CT701SP
XL1200T SuperLow	2014-2020	CK7009	CSK919	SRC7020	SRK7020	CT701SP
XL1200V Seventy-Two	2012-2016	CK7009	CSK919	SRC7020	SRK7020	CT701SP
XL1200X Forty Eight	2010-2022	CK7009	CSK919	SRC7020	SRK7020	CT701SP
XL1200XS ANV Forty Eight Anniversary	2018	CK7009	CSK919	SRC7020	SRK7020	CT701SP
XL1200XS Forty Eight Special	2018-2020	CK7009	CSK919	SRC7020	SRK7020	CT701SP
XL50 50th Anniversary	2007	CK7009	CSK919	SRC7020	SRK7020	CT701SP
XL883	1986-1990	CK7014	CSK921	SRC7024	SRK7024	CT709SP
XL883	1991-2003	CK7009	CSK920	SRC7023	SRK7023	CT701SP
XL883	2004-2009	CK7009	CSK918	SRC7021	SRK7021	CT701SP
XL883C Custom	1998-2003	CK7009	CSK920	SRC7023	SRK7023	CT701SP
XL883C Custom	2004-2010	CK7009	CSK918	SRC7021	SRK7021	CT701SP
XL883DLX Deluxe	1986-1990	CK7014	CSK921	SRC7024	SRK7024	CT709SP
XL883DLX Deluxe	1991-1995	CK7009	CSK920	SRC7023	SRK7023	CT701SP
XL883HUG Hugger	1987-1990	CK7014	CSK921	SRC7024	SRK7024	CT709SP
XL883HUG Hugger	1991-2003	CK7009	CSK920	SRC7023	SRK7023	CT701SP
XL883L Low	2005-2011	CK7009	CSK918	SRC7021	SRK7021	CT701SP
XL883L SuperLow	2012-2020	CK7009	CSK918	SRC7021	SRK7021	CT701SP
XL883N 4LE2 Iron	2009-2022	CK7009	CSK918	SRC7021	SRK7021	CT701SP
XL883R	2002-2006	CK7009	CSK920	SRC7023	SRK7023	CT701SP
XL883R	2007-2010	CK7009	CSK918	SRC7021	SRK7021	CT701SP
XL883R Roadster	2011-2015	CK7009	CSK918	SRC7021	SRK7021	CT701SP
XLH 1000	1984	CK7014	CSK921	SRC7024	SRK7024	CT709SP
XLH 1000	1981-1984	CK7015	CSK257	SRC7025	SRK7025	CT709SP
XLH 1000 Standard	1970	CK7016				
XLH 1000 Standard	1970	CK7016				
XLH 1000 Standard	1971-1978	CK7015	CSK256	SRC7025	SRK7025	CT709SP
XLH 1000 Standard	1971-1978	CK7015	CSK257	SRC7025	SRK7025	CT709SP
XLH1100	1986-1990	CK7014	CSK921	SRC7024	SRK7024	CT709SP
XLH1200	1988-1990	CK7014	CSK921	SRC7024	SRK7024	CT709SP
XLHC 1000	1979-1980	CK7015	CSK257	SRC7025	SRK7025	CT709SP
XLS1000 Roadster	1984	CK7014	CSK921	SRC7024	SRK7024	CT709SP
XLS1000 Roadster	1981-1984	CK7015	CSK257	SRC7025	SRK7025	CT709SP
XR1000	1983	CK7015	CSK257	SRC7025	SRK7025	CT709SP
XR1000	1984	CK7014	CSK921	SRC7024	SRK7024	CT709SP
XR1000	1984	CK7015	CSK257	SRC7025	SRK7025	CT709SP
XR1200	2008-2010	CK7013	CSK913	SRC7022	SRK7022	CT701SP
XR1200X	2010-2013	CK7013	CSK913	SRC7022	SRK7022	CT701SP

EBC BRAKES CLUTCH KITS



HARLEY-DAVIDSON®



		CK Series Moulded OEM style facings #	CSK Spring Kit #	SRC Series Kit #	SRK Series Kit #	CT Tool #
STREET						
XG500	2015-2020	CK7004	CSK230			
XG750	2015-2020	CK7004	CSK229			
DYNA						
FLD 103 Switchback	2012-2016	CK7008	CSK916	SRC7012	SRK7012	CT703SP
FLD Dyna Switchback	2012-2017	CK7008	CSK915	SRC7013	SRK7013	CT703SP
FXD Super Glide	1995-1997	CK7009		SRC7019	SRK7019	CT701SP
FXD Super Glide	1998-2003	CK7008	CSK917	SRC7011	SRK7011	CT703SP
FXD Super Glide	2004-2005	CK7008	CSK916	SRC7012	SRK7012	CT703SP
FXD Super Glide	2007-2010	CK7008	CSK915	SRC7013	SRK7013	CT703SP
FXD35 35th Anniversary Super Glide	2006	CK7008	CSK915	SRC7013	SRK7013	CT703SP
FXDB 103 Street Bob	2014-2017	CK7008	CSK916	SRC7012	SRK7012	CT703SP
FXDB Daytona	1992	CK7009		SRC7019	SRK7019	CT701SP
FXDB Street Bob	2007-2017	CK7008	CSK915	SRC7013	SRK7013	CT703SP
FXDB Sturgis	1991	CK7009		SRC7019	SRK7019	CT701SP
FXDBA 103 Street Bob	2013-2015	CK7008	CSK916	SRC7012	SRK7012	CT703SP
FXDBA Street Bob HD-1	2013-2015	CK7008	CSK915	SRC7013	SRK7013	CT703SP
FXDBC 103 Street Bob Limited	2016	CK7008	CSK916	SRC7012	SRK7012	CT703SP
FXDBC Street Bob Limited	2016	CK7008	CSK915	SRC7013	SRK7013	CT703SP
FXDBI Street Bob	2006	CK7008	CSK915	SRC7013	SRK7013	CT703SP
FXDBP 103 Street Bob	2016	CK7008	CSK916	SRC7012	SRK7012	CT703SP
FXDC 103 Super Glide Custom	2014	CK7008	CSK916	SRC7012	SRK7012	CT703SP
FXDC Super Glide Custom	1992	CK7009		SRC7019	SRK7019	CT701SP
FXDC Super Glide Custom	2005	CK7008	CSK916	SRC7012	SRK7012	CT703SP
FXDC Super Glide Custom	2007-2014	CK7008	CSK915	SRC7013	SRK7013	CT703SP
FXDCANV Super Glide Custom Anniversary	2013	CK7008	CSK915	SRC7013	SRK7013	CT703SP
FXDCI Super Glide Custom	2005-2006	CK7008	CSK915	SRC7013	SRK7013	CT703SP
FXDF Fat Bob	2008-2011	CK7008	CSK915	SRC7013	SRK7013	CT703SP
FXDF Fat Bob	2012-2017	CK7008	CSK916	SRC7012	SRK7012	CT703SP
FXDG Glide Glide Custom	1983	CK7012	CSK255	SRC7018	SRK7018	CT704SP
FXDI Super Glide	2004-2006	CK7008	CSK915	SRC7013	SRK7013	CT703SP
FXDL Low Rider	1993-1997	CK7009		SRC7019	SRK7019	CT701SP
FXDL Low Rider	1998-2003	CK7008	CSK917	SRC7011	SRK7011	CT703SP
FXDL Low Rider	2006-2017	CK7008	CSK915	SRC7013	SRK7013	CT703SP
FXDL Low Rider	2014-2017	CK7008	CSK916	SRC7012	SRK7012	CT703SP
FXDL/I Low Rider	2004-2005	CK7008	CSK916	SRC7012	SRK7012	CT703SP
FXDLS Low Rider S	2016-2017	CK7008	CSK914	SRC7009	SRK7009	CT703SP
FXDSCONV Glide Convertible	1993	CK7009		SRC7019	SRK7019	CT701SP
FXDSCONV Glide Convertible	1999-2000	CK7008	CSK917	SRC7011	SRK7011	CT703SP
FXDWG 103 Wide Glide	2013-2017	CK7008	CSK916	SRC7012	SRK7012	CT703SP
FXDWG Wide Glide	1993-1997	CK7009		SRC7019	SRK7019	CT701SP
FXDWG Wide Glide	1998-2005	CK7008	CSK917	SRC7011	SRK7011	CT703SP
FXDWG Wide Glide	2007-2016	CK7008	CSK915	SRC7013	SRK7013	CT703SP
FXDWGANV Wide Glide 105th Anniversary	2008	CK7008	CSK915	SRC7013	SRK7013	CT703SP
FXDWGI Wide Glide	2004-2006	CK7008	CSK916	SRC7012	SRK7012	CT703SP
FXDX Super Glide Sport	1999-2003	CK7008	CSK917	SRC7011	SRK7011	CT703SP
FXDX Super Glide Sport	2004-2005	CK7008	CSK916	SRC7012	SRK7012	CT703SP
FXDXT Super Glide T-Sport	2001-2003	CK7008	CSK917	SRC7011	SRK7011	CT703SP
FXS 103 Blackline	2012-2013			SRC7012	SRK7012	CT703SP
FXS Blackline	2011-2013			SRC7012	SRK7012	CT703SP
FXSB 103 Softail Breakout	2013-2015			SRC7012	SRK7012	CT703SP

EBC BRAKES CLUTCH KITS



HARLEY-DAVIDSON®



		CK Series Moulded OEM style facings #	CSK Spring Kit #	SRC Series Kit #	SRK Series Kit #	CT Tool #
SOFTAIL						
FLDE Deluxe	2018-2020	CK7007	CSK236	SRC7008	SRK7008	CT708SP
FLFB Fat Boy	2018-2020	CK7007	CSK236	SRC7008	SRK7008	CT708SP
FLFBS Fat Boy 114	2018-2026	CK7007	CSK236	SRC7008	SRK7008	CT708SP
FLFBS Fat Boy 114 Anniversary	2018	CK7007	CSK236	SRC7008	SRK7008	CT708SP
FLFBS Fat Boy 114 Anniversary	2020	CK7007	CSK236	SRC7008	SRK7008	CT708SP
FLFBS Fat Boy 114 Anniversary	2023	CK7007	CSK236	SRC7008	SRK7008	CT708SP
FLHC Electra Glide Classic	1981-1982	CK7012	CSK255	SRC7018	SRK7018	CT704SP
FLHC Heritage Classic	2018-2021	CK7007	CSK236	SRC7008	SRK7008	CT708SP
FLHCS Heritage Classic 114	2018-2026	CK7007	CSK236	SRC7008	SRK7008	CT708SP
FLHCS Heritage Classic 114 Anniversary	2018	CK7007	CSK236	SRC7008	SRK7008	CT708SP
FLHCS Heritage Classic 114 Anniversary	2023	CK7007	CSK236	SRC7008	SRK7008	CT708SP
FLI Hydra-Glide Revival	2024-2025	CK7007	CSK236	SRC7008	SRK7008	CT708SP
FLS 103 Slim	2012-2015	CK7008	CSK916	SRC7012	SRK7012	CT703SP
FLS Slim	2012-2015	CK7008	CSK915	SRC7013	SRK7013	CT703SP
FLS Slim	2016-2017	CK7008	CSK916	SRC7012	SRK7012	CT703SP
FLSB Sport Glide	2018-2024	CK7007	CSK236	SRC7008	SRK7008	CT708SP
FLSL Slim	2018-2021	CK7007	CSK236	SRC7008	SRK7008	CT708SP
FLSS Slim S	2016-2017	CK7002	CSK235	SRC7003	SRK7003	CT702SP
FLST Heritage	1986-1990	CK7010		SRC7016	SRK7016	CT705SP
FLST Heritage	2006	CK7008	CSK915	SRC7013	SRK7013	CT703SP
FLST Heritage	2008-2009	CK7008	CSK915	SRC7013	SRK7013	CT703SP
FLSTC 103 Heritage Classic	2012-2017	CK7008	CSK916	SRC7012	SRK7012	CT703SP
FLSTC Heritage Classic	1987-1989	CK7010		SRC7016	SRK7016	CT705SP
FLSTC Heritage Classic	1990-1997	CK7009		SRC7019	SRK7019	CT701SP
FLSTC Heritage Classic	1998-2003	CK7008	CSK917	SRC7011	SRK7011	CT703SP
FLSTC Heritage Classic	2006-2015	CK7008	CSK915	SRC7013	SRK7013	CT703SP
FLSTC Heritage Classic	2012-2015	CK7008	CSK915	SRC7013	SRK7013	CT703SP
FLSTC Heritage Softail Classic	2004-2005	CK7008	CSK916	SRC7012	SRK7012	CT703SP
FLSTC103ANV Heritage Classic Anniversary	2013	CK7008	CSK916	SRC7012	SRK7012	CT703SP
FLSTCANV Heritage Classic Anniversary	2013	CK7008	CSK915	SRC7013	SRK7013	CT703SP
FLSTCI Heritage Classic	2006	CK7008	CSK915	SRC7013	SRK7013	CT703SP
FLSTCI Heritage Classic	2001-2003	CK7008	CSK917	SRC7011	SRK7011	CT703SP
FLSTCI Heritage Classic Shrine	2005	CK7008	CSK916	SRC7012	SRK7012	CT703SP
FLSTCI Heritage Softail Classic	2004-2005	CK7008	CSK916	SRC7012	SRK7012	CT703SP
FLSTF Fat Boy	1990-1997	CK7009		SRC7019	SRK7019	CT701SP
FLSTF Fat Boy	1998-2003	CK7008	CSK917	SRC7011	SRK7011	CT703SP
FLSTF Fat Boy	2004-2005	CK7008	CSK916	SRC7012	SRK7012	CT703SP
FLSTF Fat Boy	2006-2011	CK7008	CSK915	SRC7013	SRK7013	CT703SP
FLSTF Fat Boy	2012-2017	CK7008	CSK916	SRC7012	SRK7012	CT703SP
FLSTFB Fat Boy LO	2010-2011	CK7008	CSK915	SRC7013	SRK7013	CT703SP
FLSTFB Fat Boy LO	2012-2017	CK7008	CSK916	SRC7012	SRK7012	CT703SP
FLSTFBANV Fat Boy LO Anniversary	2013	CK7008	CSK916	SRC7012	SRK7012	CT703SP
FLSTFBS Fat Boy S	2016-2017	CK7002	CSK916	SRC7012	SRK7012	CT702SP
FLSTFI Fat Boy	2006	CK7008	CSK915	SRC7013	SRK7013	CT703SP
FLSTFI Fat Boy	2001-2003	CK7008	CSK917	SRC7011	SRK7011	CT703SP
FLSTFI Fat Boy	2004-2005	CK7008	CSK916	SRC7012	SRK7012	CT703SP
FLSTFI Fat Boy Shrine	2005-2006	CK7008	CSK916	SRC7012	SRK7012	CT703SP
FLSTN Deluxe	2005-2015	CK7008	CSK916	SRC7012	SRK7012	CT703SP
FLSTN Deluxe	2012-2017	CK7008	CSK916	SRC7012	SRK7012	CT703SP
FLSTN Heritage Nostalgia	1993-1996	CK7009		SRC7019	SRK7019	CT701SP
FLSTNI Deluxe	2006	CK7008	CSK915	SRC7013	SRK7013	CT703SP
FLSTS Heritage Springer	1997	CK7009		SRC7019	SRK7019	CT701SP
FLSTS Heritage Springer	1998-2003	CK7008	CSK917	SRC7011	SRK7011	CT703SP
FLSTSB Cross Bones	2008-2011	CK7008	CSK915	SRC7013	SRK7013	CT703SP
FLSTSC Springer Classic	2006-2007	CK7008	CSK915	SRC7013	SRK7013	CT703SP
FLSTSC Springer Classic	2005	CK7008	CSK916	SRC7012	SRK7012	CT703SP

EBC BRAKES CLUTCH KITS



HARLEY-DAVIDSON®



		CK Series Moulded OEM style facings #	CSK Spring Kit #	SRC Series Kit #	SRK Series Kit #	CT Tool #
FLSTSI Heritage Springer	2001-2003	CK7008	CSK917	SRC7011	SRK7011	CT703SP
FXB BDKB Super Glide B80	1981-1982	CK7012	CSK255	SRC7018	SRK7018	CT704SP
FXBBS Street Bob	2018-2020	CK7007	CSK236	SRC7008	SRK7008	CT708SP
FXBBS Street Bob 114	2021-2026	CK7007	CSK236	SRC7008	SRK7008	CT708SP
FXBR Breakout	2018-2024	CK7007	CSK236	SRC7008	SRK7008	CT708SP
FXBRS Breakout 114	2018-2026	CK7007	CSK236	SRC7008	SRK7008	CT708SP
FXBRS Breakout 114 Anniversary	2018	CK7007	CSK236	SRC7008	SRK7008	CT708SP
FXCW Rocker	2008-2009	CK7008	CSK915	SRC7013	SRK7013	CT703SP
FXCWC Rocker C	2008-2011	CK7008	CSK915	SRC7013	SRK7013	CT703SP
FXDR 114	2019-2020	CK7007	CSK236	SRC7008	SRK7008	CT708SP
FXE Super Glide	1984	CK7010	CSK919	SRC7016	SRK7016	CT705SP
FXE Super Glide	1981-1984	CK7012	CSK255	SRC7018	SRK7018	CT704SP
FXEF Super Glide Fat Bob	1981	CK7012	CSK255	SRC7018	SRK7018	CT704SP
FXEF Super Glide Fat Bob	1985	CK7010	CSK919	SRC7016	SRK7016	CT705SP
FXFB Fat Bob	2018-2020	CK7007	CSK236	SRC7008	SRK7008	CT708SP
FXFBS Fat Bob 114	2018-2024	CK7007	CSK236	SRC7008	SRK7008	CT708SP
FXLR Low Rider	2018-2020	CK7007	CSK236	SRC7008	SRK7008	CT708SP
FXLRS Low Rider S	2020-2026	CK7007	CSK236	SRC7008	SRK7008	CT708SP
FXLRS Low Rider ST	2022-2026	CK7007	CSK236	SRC7008	SRK7008	CT708SP
FXRST Low Rider EL DIABLO	2022	CK7007	CSK236	SRC7008	SRK7008	CT708SP
FXS Blackline	2011	CK7008	CSK915	SRC7013	SRK7013	CT703SP
FXS Blackline	2012	CK7008	CSK916	SRC7012	SRK7012	CT703SP
FXS Blackline	2013	CK7008	CSK915	SRC7013	SRK7013	CT703SP
FXS Super Glide	1981-1982	CK7012	CSK255	SRC7018	SRK7018	CT704SP
FXSB 103 Breakout	2013-2015	CK7008	CSK916	SRC7012	SRK7012	CT703SP
FXSB Breakout	2013-2017	CK7008	CSK915	SRC7013	SRK7013	CT703SP
FXSB Low Rider	1985	CK7010		SRC7016	SRK7016	CT705SP
FXSB Low Rider	1983-1984	CK7012	CSK255	SRC7018	SRK7018	CT704SP
FXST Standard	1984-1989	CK7010		SRC7016	SRK7016	CT705SP
FXST Standard	1990	CK7009		SRC7019	SRK7019	CT701SP
FXST Standard	1999-2003	CK7008	CSK917	SRC7011	SRK7011	CT703SP
FXST Standard	2004-2006	CK7008	CSK916	SRC7012	SRK7012	CT703SP
FXST Standard	2007-2011	CK7008	CSK915	SRC7013	SRK7013	CT703SP
FXST Standard	2012-2015	CK7008	CSK916	SRC7012	SRK7012	CT703SP
FXST Standard	2020-2024	CK7007	CSK236	SRC7008	SRK7008	CT708SP
FXST Standard	1984	CK7012	CSK255	SRC7018	SRK7018	CT704SP
FXSTB Night Train	1999-2003	CK7008	CSK917	SRC7011	SRK7011	CT703SP
FXSTB Night Train	2004-2005	CK7008	CSK916	SRC7012	SRK7012	CT703SP
FXSTB Night Train	2006-2009	CK7008	CSK915	SRC7013	SRK7013	CT703SP
FXSTBI Night Train	2006	CK7008	CSK915	SRC7013	SRK7013	CT703SP
FXSTBI Night Train	2001-2003	CK7008	CSK917	SRC7011	SRK7011	CT703SP
FXSTBI Night Train	2004-2005	CK7008	CSK916	SRC7012	SRK7012	CT703SP
FXSTC Custom	1986-1989	CK7010		SRC7016	SRK7016	CT705SP
FXSTC Custom	1990-1997	CK7009		SRC7019	SRK7019	CT701SP
FXSTC Custom	1998-1999	CK7008	CSK917	SRC7011	SRK7011	CT703SP
FXSTC Custom	2007-2010	CK7008	CSK915	SRC7013	SRK7013	CT703SP
FXSTD Deuce	2000-2003	CK7008	CSK917	SRC7011	SRK7011	CT703SP
FXSTD Deuce	2004-2005	CK7008	CSK916	SRC7012	SRK7012	CT703SP
FXSTD Deuce	2006-2007	CK7008	CSK915	SRC7013	SRK7013	CT703SP
FXSTDI Deuce	2006	CK7008	CSK915	SRC7013	SRK7013	CT703SP
FXSTDI Deuce	2004-2005	CK7008	CSK916	SRC7012	SRK7012	CT703SP
FXSTI Standard	2006	CK7008	CSK915	SRC7013	SRK7013	CT703SP
FXSTI Standard	2001-2003	CK7008	CSK917	SRC7011	SRK7011	CT703SP
FXSTI Standard	2004-2005	CK7008	CSK916	SRC7012	SRK7012	CT703SP
FXSTS Springer	1988-1989	CK7010		SRC7016	SRK7016	CT705SP
FXSTS Springer	1990-1998	CK7009		SRC7019	SRK7019	CT701SP
FXSTS Springer	2006	CK7008	CSK915	SRC7013	SRK7013	CT703SP

EBC BRAKES CLUTCH KITS



HARLEY-DAVIDSON®



		CK Series Moulded OEM style facings #	CSK Spring Kit #	SRC Series Kit #	SRK Series Kit #	CT Tool #
FXSTS Springer	1999-2003	CK7008	CSK917	SRC7011	SRK7011	CT703SP
FXSTS Springer	2004-2005	CK7008	CSK916	SRC7012	SRK7012	CT703SP
FXSTSI Springer	2006	CK7008	CSK915	SRC7013	SRK7013	CT703SP
FXSTSI Springer	2001-2003	CK7008	CSK917	SRC7011	SRK7011	CT703SP
FXSTSI Springer	2004-2005	CK7008	CSK916	SRC7012	SRK7012	CT703SP
FXWG Wide Glide	1981-1984	CK7012	CSK255	SRC7018	SRK7018	CT704SP
FXWG Wide Glide	1984-1986	CK7010	CSK919	SRC7016	SRK7016	CT705SP
TOURING						
FLH Electra Glide	1984	CK7011	CSK255	SRC7017	SRK7017	CT704SP
FLH Electra Glide	1981-1983	CK7012	CSK255	SRC7018	SRK7018	CT704SP
FLH Electra Glide Shrine Shovelhead	1983	CK7012	CSK255	SRC7018	SRK7018	CT704SP
FLH Electra Glide Shrine Shovelhead	1984	CK7011	CSK255	SRC7017	SRK7017	CT704SP
FLH Revival	2021	CK7007	CSK236	SRC7008	SRK7008	CT708SP
FLHFB Electra Glide Highway King	2023	CK7007	CSK236	SRC7008	SRK7008	CT708SP
FLHP Road King Police	2011-2016	CK7008	CSK914	SRC7009	SRK7009	CT703SP
FLHP Road King Police	2017-2023	CK7007	CSK236	SRC7008	SRK7008	CT708SP
FLHPE Road King Police	2011	CK7008	CSK914	SRC7009	SRK7009	CT703SP
FLHR 103 Road King	2011	CK7008	CSK916	SRC7012	SRK7012	CT703SP
FLHR 96 Road King	2011	CK7008	CSK915	SRC7013	SRK7013	CT703SP
FLHR Road King	1993-1997	CK7009		SRC7014	SRK7014	CT701SP
FLHR Road King	1998-2003	CK7008	CSK917	SRC7011	SRK7011	CT703SP
FLHR Road King	2004-2006	CK7008	CSK916	SRC7012	SRK7012	CT703SP
FLHR Road King	2007-2011	CK7008	CSK915	SRC7013	SRK7013	CT703SP
FLHR Road King	2012-2013	CK7008	CSK916	SRC7012	SRK7012	CT703SP
FLHR Road King	2015-2016	CK7008	CSK917	SRC7011	SRK7011	CT703SP
FLHR Road King	2017-2022	CK7007	CSK236	SRC7008	SRK7008	CT708SP
FLHRANV Road King Anniversary	2013	CK7008	CSK916	SRC7012	SRK7012	CT703SP
FLHRC Road King Classic	2007-2011	CK7008	CSK915	SRC7013	SRK7013	CT703SP
FLHRC Road King Classic	2014-2016	CK7008	CSK917	SRC7011	SRK7011	CT703SP
FLHRC Road King Classic	2011-2013	CK7008	CSK916	SRC7012	SRK7012	CT703SP
FLHRC Road King Classic	2017-2019	CK7007	CSK236	SRC7008	SRK7008	CT708SP
FLHRCI Road King Classic	2005	CK7008	CSK916	SRC7012	SRK7012	CT703SP
FLHRCI Road King Classic	2006	CK7008	CSK915	SRC7013	SRK7013	CT703SP
FLHRCI Road King Classic	1998-2003	CK7008	CSK917	SRC7011	SRK7011	CT703SP
FLHRCI Road King Classic	2004	CK7008	CSK916	SRC7012	SRK7012	CT703SP
FLHRI Road King	2006	CK7008	CSK915	SRC7013	SRK7013	CT703SP
FLHRI Road King	2000-2003	CK7008	CSK917	SRC7011	SRK7011	CT703SP
FLHRI Road King	2004-2005	CK7008	CSK916	SRC7012	SRK7012	CT703SP
FLHRS Road King Custom	2004-2005	CK7008	CSK916	SRC7012	SRK7012	CT703SP
FLHRS Road King Custom	2006-2007	CK7008	CSK915	SRC7013	SRK7013	CT703SP
FLHRSI Road King Custom	2006	CK7008	CSK915	SRC7013	SRK7013	CT703SP
FLHRSI Road King Custom	2004-2005	CK7008	CSK916	SRC7012	SRK7012	CT703SP
FLHRXS Road King Special	2017-2023	CK7007	CSK236	SRC7008	SRK7008	CT708SP
FLHS Electra Glide Heritage	1981	CK7012	CSK255	SRC7018	SRK7018	CT704SP
FLHS Electra Glide Sport	1984	CK7011	CSK255	SRC7017	SRK7017	CT704SP
FLHS Electra Glide Sport	1981-1983	CK7012	CSK255	SRC7018	SRK7018	CT704SP
FLHS Electra Glide Sport	1984-1989	CK7010	CSK919	SRC7016	SRK7016	CT705SP
FLHS Electra Glide Sport	1991-1994	CK7009		SRC7014	SRK7014	CT701SP
FLHS Touring Electra Glide Sport	1990	CK7009	CSK913	SRC7015	SRK7015	CT701SP
FLHT Electra Glide	1984	CK7011	CSK255	SRC7017	SRK7017	CT704SP
FLHT Electra Glide	1984	CK7010	CSK919	SRC7016	SRK7016	CT705SP
FLHT Electra Glide - Early 1984	1984	CK7011	CSK255	SRC7017	SRK7017	CT704SP
FLHT Electra Glide - Later 1984	1984	CK7010	CSK919	SRC7016	SRK7016	CT705SP
FLHT Electra Glide Classic	1983	CK7012	CSK255	SRC7018	SRK7018	CT704SP
FLHT Electra Glide Classic	1984			SRC7017	SRK7017	CT704SP
FLHT Electra Glide Classic	1984	CK7010	CSK919	SRC7016	SRK7016	CT704SP

EBC BRAKES CLUTCH KITS



HARLEY-DAVIDSON®



		CK Series Moulded OEM style facings #	CSK Spring Kit #	SRC Series Kit #	SRK Series Kit #	CT Tool #
FLHT Electra Glide Classic - Early 1984	1984	CK7011	CSK255	SRC7017	SRK7017	CT704SP
FLHT Electra Glide Classic - Later 1984	1984	CK7010	CSK919	SRC7016	SRK7016	CT705SP
FLHT Electra Glide Shrine Shovelhead	1984	CK7010	CSK919	SRC7016	SRK7016	CT705SP
FLHT Electra Glide Standard	1983	CK7012	CSK255	SRC7018	SRK7018	CT704SP
FLHT Electra Glide Standard	1988	CK7010	CSK919	SRC7016	SRK7016	CT705SP
FLHT Electra Glide Standard	1994-1997	CK7009		SRC7014	SRK7014	CT701SP
FLHT Electra Glide Standard	1998-2003	CK7008	CSK917	SRC7011	SRK7011	CT703SP
FLHT Electra Glide Standard	2004-2005	CK7008	CSK916	SRC7012	SRK7012	CT703SP
FLHT Electra Glide Standard	2006-2010	CK7008	CSK915	SRC7013	SRK7013	CT703SP
FLHT Electra Glide Standard	2019-2022	CK7007	CSK236	SRC7008	SRK7008	CT708SP
FLHT Electra Glide	1983	CK7012	CSK255	SRC7018	SRK7018	CT704SP
FLHTC 103 Electra Glide Classic	2011	CK7008	CSK916	SRC7012	SRK7012	CT703SP
FLHTC Electra Glide Classic	1990	CK7009	CSK913	SRC7015	SRK7015	CT701SP
FLHTC Electra Glide Classic	1983-1984	CK7012	CSK255	SRC7018	SRK7018	CT704SP
FLHTC Electra Glide Classic	1985-1989	CK7010	CSK919	SRC7016	SRK7016	CT705SP
FLHTC Electra Glide Classic	1991-1997	CK7009		SRC7014	SRK7014	CT701SP
FLHTC Electra Glide Classic	1998-2003	CK7008	CSK917	SRC7011	SRK7011	CT703SP
FLHTC Electra Glide Classic	2004-2005	CK7008	CSK916	SRC7012	SRK7012	CT703SP
FLHTC Electra Glide Classic	2007-2011	CK7008	CSK915	SRC7013	SRK7013	CT703SP
FLHTC Electra Glide Classic	2012-2013	CK7008	CSK916	SRC7012	SRK7012	CT703SP
FLHTCI Electra Glide Classic	1996-1997	CK7009		SRC7014	SRK7014	CT701SP
FLHTCI Electra Glide Classic	1998-2003	CK7008	CSK917	SRC7011	SRK7011	CT703SP
FLHTCI Electra Glide Classic	2006	CK7008	CSK915	SRC7013	SRK7013	CT703SP
FLHTCI Electra Glide Classic	2004-2005	CK7008	CSK916	SRC7012	SRK7012	CT703SP
FLHTCU 103 Ultra Classic	2011	CK7008	CSK916	SRC7012	SRK7012	CT703SP
FLHTCU Electra Glide Classic Ultra	1989	CK7010	CSK919	SRC7016	SRK7016	CT705SP
FLHTCU Electra Glide Ultra Classic	2017-2019	CK7007	CSK236	SRC7008	SRK7008	CT708SP
FLHTCU TC Ultra Classic Twin-Cooled	2014-2016	CK7008	CSK917	SRC7011	SRK7011	CT703SP
FLHTCU Touring Electra Glide Classic Ultra	1990	CK7009	CSK913	SRC7015	SRK7015	CT701SP
FLHTCU Ultra Classic	1991-1997	CK7009		SRC7014	SRK7014	CT701SP
FLHTCU Ultra Classic	2007-2011	CK7008	CSK915	SRC7013	SRK7013	CT703SP
FLHTCU Ultra Classic	2012-2013	CK7008	CSK916	SRC7012	SRK7012	CT703SP
FLHTCU Ultra Classic	2014-2016	CK7008	CSK917	SRC7011	SRK7011	CT703SP
FLHTCUI Ultra Classic	1998-2003	CK7008	CSK917	SRC7011	SRK7011	CT703SP
FLHTCUI Ultra Classic	2006	CK7008	CSK915	SRC7013	SRK7013	CT703SP
FLHTCUI Ultra Classic	2004-2005	CK7008	CSK916	SRC7012	SRK7012	CT703SP
FLHTCUL TC Ultra Classic Low Twin-Cooled	2015-2016	CK7002	CSK235	SRC7003	SRK7003	CT702SP
FLHTCUL Ultra Classic Low	2015-2016	CK7002	CSK235	SRC7003	SRK7003	CT702SP
FLHTI Electra Glide Standard	2003	CK7008	CSK917	SRC7011	SRK7011	CT703SP
FLHTI Electra Glide Standard	2006	CK7008	CSK915	SRC7013	SRK7013	CT703SP
FLHTI Electra Glide Standard	2004-2005	CK7008	CSK916	SRC7012	SRK7012	CT703SP
FLHTK 1KNF Ultra Limited Shrine Edition	2017-2023	CK7007	CSK236	SRC7008	SRK7008	CT708SP
FLHTK Electra Glide Ultra Limited	2010-2013	CK7008	CSK916	SRC7012	SRK7012	CT703SP
FLHTK Ultra Limited	2014-2016	CK7008	CSK917	SRC7011	SRK7011	CT703SP
FLHTK Ultra Limited	2017-2023	CK7007	CSK236	SRC7008	SRK7008	CT708SP
FLHTKANV Electra Glide Ultra Limited Anniversary	2013	CK7008	CSK916	SRC7012	SRK7012	CT703SP
FLHTKANV Electra Glide Ultra Limited Anniversary	2018	CK7007	CSK236	SRC7008	SRK7008	CT708SP
FLHTKANV Electra Glide Ultra Limited Anniversary	2023	CK7007	CSK236	SRC7008	SRK7008	CT708SP
FLHTKL Ultra Limited Low	2015-2016	CK7002	CSK235	SRC7003	SRK7003	CT702SP
FLHTKL Ultra Limited Low	2017-2019	CK7007	CSK236	SRC7008	SRK7008	CT708SP
FLHTP Electra Glide Standard Police	2011-2016	CK7008	CSK914	SRC7009	SRK7009	CT703SP
FLHTP Electra Glide Standard Police	2017-2023	CK7007	CSK236	SRC7008	SRK7008	CT708SP
FLHX 103 Street Glide	2011	CK7008	CSK916	SRC7012	SRK7012	CT703SP
FLHX Street Glide	2012-2013	CK7008	CSK916	SRC7012	SRK7012	CT703SP
FLHX Street Glide	2014-2016	CK7008	CSK917	SRC7011	SRK7011	CT703SP
FLHX Street Glide	2017-2023	CK7007	CSK236	SRC7008	SRK7008	CT708SP
FLHX Street Glide	2006-2011	CK7008	CSK915	SRC7013	SRK7013	CT703SP

EBC BRAKES CLUTCH KITS



HARLEY-DAVIDSON®



		CK Series Moulded OEM style facings #	GSK Spring Kit #	SRC Series Kit #	SRK Series Kit #	CT Tool #
FLHXS Street Glide Special	2014-2016	CK7008	CSK917	SRC7011	SRK7011	CT703SP
FLHXS Street Glide Special	2017-2018	CK7007	CSK236	SRC7008	SRK7008	CT708SP
FLHXS Street Glide Special	2019-2023	CK7007	CSK236	SRC7008	SRK7008	CT708SP
FLHXS Street Glide Special Anniversary	2018	CK7007	CSK236	SRC7008	SRK7008	CT708SP
FLHXS Street Glide Special ST	2022	CK7007	CSK236	SRC7008	SRK7008	CT708SP
FLHXS Street Glide ST	2023	CK7007	CSK236	SRC7008	SRK7008	CT708SP
FLHXSANV Street Glide Anniversary	2018	CK7007	CSK236	SRC7008	SRK7008	CT708SP
FLHXSANV Street Glide Anniversary	2023	CK7007	CSK236	SRC7008	SRK7008	CT708SP
FLT Classic Tour Glide	1984	CK7011	CSK255	SRC7017	SRK7017	CT704SP
FLT Tour Glide	1984	CK7011	CSK255	SRC7017	SRK7017	CT704SP
FLT Tour Glide	1984	CK7010	CSK919	SRC7016	SRK7016	CT705SP
FLT Tour Glide	1981-1983	CK7012	CSK255	SRC7018	SRK7018	CT704SP
FLTC Tour Glide Classic	1980-1984	CK7012	CSK255	SRC7018	SRK7018	CT704SP
FLTC Tour Glide Classic	1985-1989	CK7010	CSK919	SRC7016	SRK7016	CT705SP
FLTC Tour Glide Classic	1990-1992	CK7009		SRC7014	SRK7014	CT701SP
FLTCU Tour Glide Classic Ultra	1989	CK7010	CSK919	SRC7016	SRK7016	CT705SP
FLTCU Tour Glide Ultra Classic	1990-1996	CK7009		SRC7014	SRK7014	CT701SP
FLTR Road Glide	1998-2003	CK7008	CSK917	SRC7011	SRK7011	CT703SP
FLTR Road Glide	2006-2009	CK7008	CSK915	SRC7013	SRK7013	CT703SP
FLTRI Road Glide	2004-2005	CK7008	CSK916	SRC7012	SRK7012	CT703SP
FLTRK Road Glide Limited	2020-2023	CK7007	CSK236	SRC7008	SRK7008	CT708SP
FLTRU Road Glide Ultra	2016	CK7008	CSK917	SRC7011	SRK7011	CT703SP
FLTRU Road Glide Ultra	2011-2013	CK7008	CSK916	SRC7012	SRK7012	CT703SP
FLTRU Road Glide Ultra	2017-2019	CK7007	CSK236	SRC7008	SRK7008	CT708SP
FLTRX 103 Road Glide Custom	2010	CK7008	CSK915	SRC7013	SRK7013	CT703SP
FLTRX 103 Road Glide Custom	2011-2013	CK7008	CSK916	SRC7012	SRK7012	CT703SP
FLTRX Road Glide	2015-2016	CK7008	CSK917	SRC7011	SRK7011	CT703SP
FLTRX Road Glide	2017-2023	CK7007	CSK236	SRC7008	SRK7008	CT708SP
FLTRXS Road Glide Special	2015-2016	CK7008	CSK917	SRC7011	SRK7011	CT703SP
FLTRXS Road Glide Special	2017-2023	CK7007	CSK236	SRC7008	SRK7008	CT708SP
CVO						
FLHTCUTGSE CVO Tri Glide	2021-2022	CK7007	CSK236	SRC7008	SRK7008	CT708SP
FLHTCUTGSE CVO Trike	2020-2022	CK7007	CSK236	SRC7008	SRK7008	CT708SP
FLHTK 103 CVO Limited	2014	CK7002	CSK235	SRC7003	SRK7003	CT702SP
FLHTKSE ANV CVO Ultra Limited Anniversary	2018	CK7007	CSK236	SRC7008	SRK7008	CT708SP
FLHTKSE CVO Limited	2017	CK7007	CSK236	SRC7008	SRK7008	CT708SP
FLHTKSE CVO Ultra Limited	2018-2021	CK7007	CSK236	SRC7008	SRK7008	CT708SP
FLHXSE CVO Street Glide	2017-2024	CK7007	CSK236	SRC7008	SRK7008	CT708SP
FLTRXSE CVO Road Glide	2022	CK7007	CSK236	SRC7008	SRK7008	CT708SP
FLTRXSE CVO Road Glide	2018-2022	CK7007	CSK236	SRC7008	SRK7008	CT708SP
TRIKE						
FLHTCUTG ANV Tri Glide Ultra Classic Anniversary	2013	CK7008	CSK914	SRC7009	SRK7009	CT703SP
FLHTCUTG Tri Glide Ultra	2017-2023	CK7007	CSK236	SRC7008	SRK7008	CT708SP
FLHTCUTG Tri Glide Ultra Anniversary	2018	CK7007	CSK236	SRC7008	SRK7008	CT708SP
FLHTCUTG Tri Glide Ultra Anniversary	2023	CK7007	CSK236	SRC7008	SRK7008	CT708SP
FLHTCUTG Tri Glide Ultra Classic	2009-2013	CK7008	CSK914	SRC7009	SRK7009	CT703SP
FLHTCUTG Tri Glide Ultra Classic	2014-2016	CK7002	CSK235	SRC7003	SRK7003	CT702SP
FLHTCUTGANV Tri Glide Ultra Classic Anniversary	2013	CK7008	CSK914	SRC7009	SRK7009	CT703SP
FLHTCUTGSE CVO Tri Glide	2020-2022	CK7007	CSK236	SRC7008	SRK7008	CT708SP
FLHXXX Street Glide Trike	2010-2011	CK7008	CSK914	SRC7009	SRK7009	CT703SP
FLRT 1MCP Freewheeler	2017-2023	CK7007	CSK236	SRC7008	SRK7008	CT708SP
FLRT Freewheeler	2015-2016	CK7002	CSK235	SRC7003	SRK7003	CT702SP
FLTRT 1MFP Road Glide 3	2023	CK7007	CSK236	SRC7008	SRK7008	CT708SP

EBC BRAKES CLUTCH KITS



HARLEY-DAVIDSON®



		CK Series Moulded OEM style facings #	CSK Spring Kit #	SRC Series Kit #	SRK Series Kit #	CT Tool #
V-ROD						
VRSCA V-Rod	2002-2006	CK7006	CSK232	SRC7007	SRK7007	CT707SP
VRSCAW V-Rod	2009-2010	CK7005	CSK233	SRC7006	SRK7006	CT706SP
VRSCAW V-Rod Wide Tire	2007	CK7006	CSK232	SRC7007	SRK7007	CT707SP
VRSCAW V-Rod Wide Tire	2008	CK7005	CSK233	SRC7006	SRK7006	CT706SP
VRSCD Night Rod	2008	CK7005	CSK233	SRC7006	SRK7006	CT706SP
VRSCDA Night Rod	2008	CK7005	CSK233	SRC7006	SRK7006	CT706SP
VRSCDX ANV Night Rod Special Anv	2012			SRC7006	SRK7006	CT706SP
VRSCDX Night Rod Special	2008-2017	CK7005	CSK233	SRC7006	SRK7006	CT706SP
VRSCDX Night Rod Special	2018-2021	CK7005	CSK233	SRC7006	SRK7006	CT706SP
VRSCDXA Night Rod Special	2008	CK7005	CSK233	SRC7006	SRK7006	CT706SP
VRSCF Muscle 1HPH V-Rod	2018-2021	CK7005	CSK233	SRC7006	SRK7006	CT706SP
VRSCF V-Rod Muscle	2009-2017	CK7005	CSK233	SRC7006	SRK7006	CT706SP
VRSCR Street Rod	2006-2007	CK7006	CSK232	SRC7007	SRK7007	CT707SP
VRSCSE CVO V-Rod	2005-2006	CK7006	CSK232	SRC7007	SRK7007	CT707SP
VRSCX Screamin' Eagle V-Rod	2007	CK7006	CSK232	SRC7007	SRK7007	CT707SP
VRXSE CVO VR Destroyer	2006	CK7006	CSK232	SRC7007	SRK7007	CT707SP
INDIAN						
Chief	2014-2021	CK7003	CSK232	SRC7004	SRK7004	CT707SP
Chief Classic	2014-2020	CK7003	CSK232	SRC7004	SRK7004	CT707SP
Chief Dark Horse	2016-2020	CK7003	CSK232	SRC7004	SRK7004	CT707SP
Chief Vintage	2014-2020	CK7003	CSK232	SRC7004	SRK7004	CT707SP
Chieftain	2014-2018	CK7003	CSK232	SRC7004	SRK7004	CT707SP
Chieftain	2019-2021	CK7003	CSK232	SRC7004	SRK7004	CT707SP
Chieftain Dark Horse	2016-2020	CK7003	CSK232	SRC7004	SRK7004	CT707SP
Chieftain Elite	2017-2020	CK7003	CSK232	SRC7004	SRK7004	CT707SP
Chieftain Limited	2017-2018	CK7003	CSK232	SRC7004	SRK7004	CT707SP
FTR 1200	2019	CK7003	CSK232	SRC7004	SRK7004	CT707SP
FTR 1200	2019-2021	CK7003	CSK232	SRC7004	SRK7004	CT707SP
Octane	2017	CK7001	CSK231	SRC7001	SRK7001	
Roadmaster	2015-2021	CK7001	CSK231	SRC7001	SRK7001	
Roadmaster	2016-2018	CK7003	CSK232	SRC7004	SRK7004	CT707SP
Roadmaster Classic	2017-2020	CK7003	CSK232	SRC7004	SRK7004	CT707SP
Scout	2015	CK7003	CSK232	SRC7004	SRK7004	CT707SP
Scout	2016	CK7001	CSK235	SRC7002	SRK7002	
Scout	2017	CK7001	CSK231	SRC7001	SRK7001	
Scout	2017-2021	CK7001	CSK235	SRC7002	SRK7002	
Scout	2018-2020	CK7001	CSK235	SRC7002	SRK7002	
Scout Bobber	2018	CK7001	CSK235	SRC7002	SRK7002	
Scout Sixty	2016-2017	CK7001	CSK231	SRC7001	SRK7001	
Scout Sixty	2018-2020	CK7001	CSK235	SRC7002	SRK7002	
Springfield	2016	CK7001	CSK235	SRC7002	SRK7002	
Springfield	2017-2020	CK7003	CSK232	SRC7004	SRK7004	CT707SP
Springfield Dark Horse	2018	CK7003	CSK232	SRC7004	SRK7004	CT707SP

BRAKE PADS AND ROTORS FOR POLARIS SLINGSHOT



EBC BRAKE STANDARD ORGANIC BRAKE PADS

A direct equivalent to the OE brake pads, suitable for every day driving. This is our quietest pad formulation for silent braking – progressive braking with excellent cold friction.



EBC BRAKE YELLOW CODED UPGRADE BRAKE PADS

For faster driving, these pads give excellent cold bite and high temperature fade resistance. Stopping distances are drastically reduced, progressive braking with unparalleled pedal feel.



EBC BRAKE ROTORS – OE QUALITY REPLACEMENT

EBC brake rotors are cast using high quality G3000 alloy making this a premium OE quality replacement brake rotor for your Slingshot. Black thermic coated for aesthetics and corrosion protection.



EBC BRAKE ROTORS – BSD BLADE SERIES

The unique BSD blade slot design removes hot gasses from the heart of the braking zone allowing for quicker and more effective dissipation of heat.

COMPLETE VEHICLE STANDARD BRAKE KIT

This money saving kit includes one set of standard organic brake pads for both the front and rear of your vehicle, plus two OE quality brake rotors for the front and one for the rear.

COMPLETE VEHICLE UPGRADE BRAKE KIT

This upgrade kit includes one set of yellow coded upgrade brake pads for both the front and rear of your vehicle, plus two BSD blade slotted brake rotors for the front and one for the rear.



Model	Year	FRONT				REAR				FULL VEHICLE		
		STANDARD BLACK BRAKE PADS (INC. 4 PADS FOR LEFT AND RIGHT FITMENTS)	UPGRADE YELLOW BRAKE PADS (INC. 4 PADS FOR LEFT AND RIGHT FITMENTS)	STANDARD ROTOR LEFT (GROUP)	STANDARD ROTOR RIGHT (GROUP)	BSD SPORT SLOTTED ROTOR KIT (2 PCS)	STANDARD BLACK BRAKE PADS (2 PCS)	UPGRADE YELLOW BRAKE PADS (2 PCS)	STANDARD ROTOR (GROUP)	BSD SPORT SLOTTED ROTOR	COMPLETE STANDARD BRAKE KIT (1 X FRONT PADS 1 X REAR PADS 2 X FRONT ROTORS 1 X REAR ROTOR)	COMPLETE UPGRADE BRAKE KIT (1 X FRONT PADS 1 X REAR PADS 2 X FRONT ROTORS 1 X REAR ROTOR)
Slingshot Base	15-17	FA669/4	FA4669/4	019	019	MD533BSDF	FA670	FA4670	019	MD533BSDR	MDK533STD	MDK533BSD
Slingshot S	18-22	FA669/4	FA4669/4	019	019	MD533BSDF	FA670	FA4670	019	MD533BSDR	MDK533STD	MDK533BSD
Slingshot SL	15-23	FA669/4	FA4669/4	019	019	MD533BSDF	FA670	FA4670	019	MD533BSDR	MDK533STD	MDK533BSD
Slingshot SL SE	22-23	FA669/4	FA4669/4	019	019	MD533BSDF	FA670	FA4670	019	MD533BSDR	MDK533STD	MDK533BSD
Slingshot SLR	17-23	FA669/4	FA4669/4				FA670	FA4670				

FOR FULL APPLICATION INFORMATION PLEASE SEE PAGES 24-25



EBC[®] BRAKES

For **Japanese** and **European** Fitments see separate catalog.

EBC Brakes World Headquarters: Upton Valley Way East, Pineham, Northampton, United Kingdom NN4 9EF

Tel: +44 (0) 1604 583344 E-mail: sales@ebcbrakesuk.com

US Head Office: EBC Brakes USA Inc. 6180 South Pearl Street, Las Vegas, Nevada 89120

Tel: +1 (702) 826-2400 E-mail: sales@ebcbrakesusa.com

www.ebcbrakes.com

The letters EBC form a registered trademark in the United States and most countries worldwide.

Harley® and Harley-Davidson® are registered marks of Harley-Davidson Inc. 3700 W. Juneau Avenue, Milwaukee, WI 53208 United States.

Cover Image: Matt Jensen
@Matt_Jensen